

## AccuPocket 150/400 ActiveCharger 1000

EN  
Operating Instructions  
Spare parts list  
Rod electrode power source

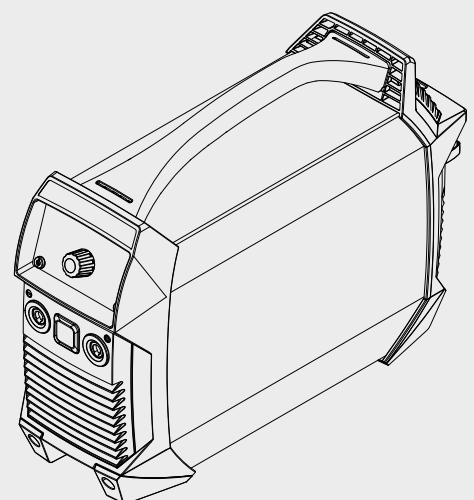



# Dear reader,

---

## **Introduction**

Thank you for the trust you have placed in our company and congratulations on buying this high-quality Fronius product. These instructions will help you familiarise yourself with the product. Reading the instructions carefully will enable you to learn about the many different features it has to offer. This will allow you to make full use of its advantages.

Please also note the safety rules to ensure greater safety when using the product. Careful handling of the product will repay you with years of safe and reliable operation. These are essential prerequisites for excellent results.



# Contents

<b>Safety rules</b>	<b>9</b>
General .....	11
Explanation of safety symbols .....	11
Operating environments.....	11
Obligations of the operator.....	12
Obligations of personnel .....	12
EMC Device Classifications .....	12
Disposal .....	12
Data protection.....	12
Copyright.....	13
Power source .....	14
General .....	14
Proper use .....	14
Protecting yourself and others .....	15
Noise emission values .....	15
Danger from toxic gases and vapours .....	16
Danger from flying sparks .....	16
Dangers from welding current.....	16
Dangers from the battery .....	17
Meandering welding currents.....	18
EMC measures .....	18
EMF measures.....	19
Factors affecting welding results.....	19
Danger from shielding gas cylinders.....	19
Danger from escaping shielding gas.....	20
Safety precautions in the place of use and for storage and transport.....	20
Safety measures in normal operation .....	20
Safety inspection.....	21
Commissioning, maintenance and repair.....	21
Safety symbols.....	21
Charger .....	22
General .....	22
Proper use .....	22
Mains connection .....	22
Dangers from mains current and charging current .....	23
Protecting yourself and others .....	23
Safety measures in normal operation .....	23
EMC measures .....	23
Maintenance and repair .....	24
Warranty and liability.....	24
Safety inspection.....	24
Safety symbols.....	24
<b>Power source</b>	<b>27</b>
General .....	29
Device concept .....	29
Warning notices on the device.....	29
Application areas .....	30
Using rechargeable devices.....	31
Safety.....	31
Storage and transport .....	31
Service life of the battery .....	31
Battery protection functions .....	33
General .....	33
Deep discharge protector.....	33
Automatic switch-off.....	33
Temperature monitoring.....	34

Overcharging protection.....	34
Before commissioning.....	35
Safety.....	35
Proper use.....	35
Setup regulations.....	35
Power connection.....	35
Before starting for the first time.....	36
Control elements and connections.....	37
Safety.....	37
Connections and mechanical components.....	38
Control panel.....	39
MMA welding.....	43
Preparatory work.....	43
MMA welding.....	43
SoftStart / HotStart function.....	43
Arc-force dynamic.....	44
TIG welding.....	46
General.....	46
Connecting the gas cylinder.....	46
Preparatory work.....	46
Setting the gas pressure.....	47
TIG welding.....	47
TIG Comfort Stop.....	48
The Setup menu.....	50
Accessing the Setup menu.....	50
Changing welding parameters.....	50
Exiting the Setup menu.....	50
Parameters for MMA welding.....	50
Parameters for TIG welding.....	51
VRD safety device (optional).....	53
General.....	53
Function.....	53
Care, maintenance and disposal.....	54
Safety.....	54
General.....	54
At every start-up.....	54
Every 2 months.....	55
Disposal.....	55
Troubleshooting.....	56
Safety.....	56
Indicated errors.....	56
Service messages.....	57
No function.....	58
Faulty operation.....	59
Technical data.....	61
Operating environments.....	61
Explanation of the term "duty cycle".....	61
Technical data.....	62

**Charger** **63**

General.....	65
Warning notices on the device.....	65
Warning notices inside the device.....	66
Proper use.....	66
Before commissioning.....	67
Mains connection.....	67
Generator-powered operation.....	67
Setup regulations.....	67
Space requirements.....	68
Control elements and connections.....	69
Safety.....	69
Connections and components.....	69
Control panel.....	69

Start-up .....	70
Safety .....	70
Commissioning .....	70
Operating modes .....	71
Options .....	72
Fitting the wall bracket .....	72
Troubleshooting .....	73
Safety .....	73
Indicated errors .....	73
No function .....	73
Technical data .....	74
Operating environments .....	74
Technical data 230V .....	74
Standards 230V .....	75
Technical data 120V .....	75
Standards 120V .....	75
Technical data 100V .....	75
Standards 100V .....	76
<b>Appendix</b> .....	<b>77</b>
Spare parts list: AccuPocket .....	78
Spare parts list: ActiveCharger .....	79





# **Safety rules**



# General

## Explanation of safety symbols



### **DANGER!**

**Indicates immediate and real danger.**

If it is not avoided, death or serious injury will result.



### **WARNING!**

**Indicates a potentially dangerous situation.**

Death or serious injury may result if appropriate precautions are not taken.



### **CAUTION!**

**Indicates a situation where damage or injury could occur.**

If it is not avoided, minor injury and/or damage to property may result.

### **NOTE!**

**Indicates a risk of flawed results and possible damage to the equipment.**

### **IMPORTANT!**

**Indicates tips for correct operation and other particularly useful information.**

It does not indicate a potentially damaging or dangerous situation.

If you see any of the symbols depicted in the "Safety rules" chapter, special care is required.

## Operating environments

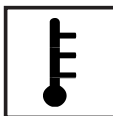

Transport, storage or operation of the charger outside the stipulated area will be deemed improper. The manufacturer shall not be held liable for any damage arising from such usage.

Ambient temperature range:

- during operation: -10 °C to +40 °C (14 °F to 104 °F)
- during transport and storage: -20 °C to +55 °C (-4 °F to 131 °F)
- recommended temperature range during charging: + 4 °C to + 40 °C (+ 39,2 °F to + 104 °F)

Relative humidity:

- up to 50 % at 40 °C (104 °F)
- up to 90 % at 20 °C (68 °F)

The surrounding air must be free from dust, acids, corrosive gases or substances, etc.

Can be used at altitudes up to 2000 m (6561 ft.)

---

## Obligations of the operator



- The operator must only allow persons to work with the device who:
- are familiar with the fundamental instructions regarding safety at work and accident prevention and have been instructed in how to use the device
  - have read and understood these operating instructions, especially the section "safety rules", and have confirmed as much with their signatures
  - are trained to produce the required results.

---

Checks must be carried out at regular intervals to ensure that operators are working in a safety-conscious manner.

---

## Obligations of personnel

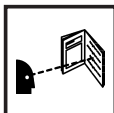

- Before using the device, all persons instructed to do so undertake:
- to observe the basic instructions regarding safety at work and accident prevention
  - to read these operating instructions, especially the "Safety rules" section and sign to confirm that they have understood them and will follow them.

---

Before leaving the workplace, ensure that people or property cannot come to any harm in your absence.

---

## EMC Device Classifications



Devices in emission class A:

- Are only designed for use in industrial settings
- Can cause line-bound and radiated interference in other areas

---

Devices in emission class B:

- Satisfy the emissions criteria for residential and industrial areas. This is also true for residential areas in which the energy is supplied from the public low-voltage mains.

---

EMC device classification as per the rating plate or technical data.

---

## Disposal



Do not dispose of this device with normal domestic waste! To comply with the European Directive on Waste Electrical and Electronic Equipment and its implementation as national law, electrical equipment that has reached the end of its life must be collected separately and returned to an approved recycling facility. Any device that you no longer require must either be returned to your dealer or given to one of the approved collection and recycling facilities in your area. Ignoring this European Directive may have potentially adverse effects on the environment and your health!

---

## Data protection

The user is responsible for the safekeeping of any changes made to the factory settings. The manufacturer accepts no liability for any deleted personal settings.

---

## Copyright



Copyright of these operating instructions remains with the manufacturer.

The text and illustrations are all technically correct at the time of printing. We reserve the right to make changes. The contents of the operating instructions shall not provide the basis for any claims whatsoever on the part of the purchaser. If you have any suggestions for improvement, or can point out any mistakes that you have found in the instructions, we will be most grateful for your comments.

# Power source

---

## General



The device is manufactured using state-of-the-art technology and according to recognised safety standards. If used incorrectly or misused, however, it can cause:

- injury or death to the operator or a third party,
- damage to the device and other material assets belonging to the operating company,
- inefficient operation of the device.

---

All persons involved in commissioning, operating, maintaining and servicing the device must:

- be suitably qualified,
- have sufficient knowledge of welding and
- read and follow these operating instructions carefully.

---

The operating instructions must always be at hand wherever the device is being used. In addition to the operating instructions, attention must also be paid to any generally applicable and local regulations regarding accident prevention and environmental protection.

---

All safety and danger notices on the device

- must be in a legible state,
- must not be damaged,
- must not be removed,
- must not be covered, pasted or painted over.

---

For the location of the safety and danger notices on the device, refer to the section headed "General" in the operating instructions for the device. Before switching on the device, rectify any faults that could compromise safety.

**This is for your personal safety!**

---

## Proper use



The device is to be used exclusively for its intended purpose.

---

The device is intended solely for the welding processes specified on the rating plate.

Any use above and beyond this purpose is deemed improper. The manufacturer shall not be held liable for any damage arising from such usage.

---

Proper use includes:

- carefully reading and following all the instructions given in the operating instructions
- studying and obeying all safety and danger notices carefully
- performing all stipulated inspection and maintenance work.

---

Never use the device for the following purposes:

- Thawing out pipes
- Charging batteries
- Starting engines

---

The device is designed for use in industry and the workshop. The manufacturer accepts no responsibility for any damage caused through use in a domestic setting.

---

The manufacturer likewise accepts no liability for inadequate or incorrect results.

---

**Protecting yourself and others**



Anyone working with the device exposes themselves to numerous risks, e.g.

- flying sparks and hot pieces of metal
- Arc radiation, which can damage eyes and skin



- Hazardous electromagnetic fields, which can endanger the lives of those using cardiac pacemakers



- Risk of electrocution from mains current and welding current



- Greater noise pollution



- Harmful welding fumes and gases

Suitable protective clothing must be worn when working with the device. The protective clothing must have the following properties:

- Flame-resistant
- Insulating and dry
- Covers the whole body, is undamaged and in good condition
- Safety helmet
- Trousers with no turn-ups



Protective clothing refers to a variety of different items. Operators should:

- Protect eyes and face from UV rays, heat and sparks using a protective visor and regulation filter
- Wear regulation protective goggles with side protection behind the protective visor
- Wear stout footwear that provides insulation even in wet conditions
- Protect the hands with suitable gloves (electrically insulated and providing protection against heat)
- Wear ear protection to reduce the harmful effects of noise and to prevent injury



Keep all persons, especially children, out of the working area while any devices are in operation or welding is in progress. If, however, there are people in the vicinity:

- Make them aware of all the dangers (risk of dazzling by the arc, injury from flying sparks, harmful welding fumes, noise, possible risks from mains current and welding current, etc.)
- Provide suitable protective equipment
- Alternatively, erect suitable safety screens/curtains.

**Noise emission values**



The device generates a maximum sound power level of <math><80\text{ dB(A)}</math> (ref. 1pW) when idling and in the cooling phase following operation at the maximum permissible operating point under maximum rated load conditions according to EN 60974-1.

It is not possible to provide a workplace-related emission value during welding (or cutting) as this is influenced by both the process and the environment. All manner of different welding parameters come into play, including the welding process (MIG/MAG, TIG welding), the type of power selected (DC or AC), the power range, the type of weld metal, the resonance characteristics of the workpiece, the workplace environment, etc.

**Danger from toxic gases and vapours**



The fumes produced during welding contain harmful gases and vapours.

Welding fumes contain substances that may, under certain circumstances, cause birth defects or cancer.

Keep your face away from welding fumes and gases.

Fumes and hazardous gases

- must not be breathed in
- must be extracted from the working area using appropriate methods.

Ensure an adequate supply of fresh air with a ventilation rate of at least 20 m<sup>3</sup>/hour.

Otherwise, a protective mask with an air supply must be worn.

Close the shielding gas cylinder valve or main gas supply if no welding is taking place.

If there is any doubt about whether the extraction capacity is sufficient, the measured toxic emission values should be compared with the permissible limit values.

Amongst others, the following components are responsible for the degree of toxicity of welding fumes:

- Metals used for the workpiece
- Electrodes
- Coatings
- Cleaners, degreasers, etc.

The relevant material safety data sheets and manufacturer's specifications for the listed components should therefore be studied carefully.

Flammable vapours (e.g. solvent fumes) should be kept away from the arc's radiation area.

**Danger from flying sparks**



Flying sparks may cause fires or explosions.

Never weld close to flammable materials.

Flammable materials must be at least 11 metres (36 ft. 1.07 in.) away from the arc, or alternatively covered with an approved cover.

A suitable, tested fire extinguisher must be available and ready for use.

Sparks and pieces of hot metal may also get into adjacent areas through small gaps or openings. Take appropriate precautions to prevent any danger of injury or fire.

Welding must not be performed in areas that are subject to fire or explosion or near sealed tanks, vessels or pipes unless these have been prepared in accordance with the relevant national and international standards.

Do not carry out welding on containers that are being or have been used to store gases, propellants, mineral oils or similar products. Residues pose an explosive hazard.

**Dangers from welding current**



An electric shock is potentially life threatening and can be fatal.

Do not touch live parts either inside or outside the device.





Make sure that you and others are protected with an adequately insulated, dry temporary backing or cover for the earth or ground potential. This temporary backing or cover must extend over the entire area between the body and the earth or ground potential.

All cables and leads must be secured, undamaged, insulated and adequately dimensioned. Loose connections, scorched, damaged or inadequately dimensioned cables and leads must be replaced immediately.

Do not sling cables or leads around the body or parts of the body.

The electrode (rod electrode, tungsten electrode, welding wire, etc.) must

- never be immersed in liquid for cooling
- never be touched when the power source is switched on.

Double the open circuit voltage of a power source can occur between the welding electrodes of two power sources. Touching the potentials of both electrodes at the same time may be fatal under certain circumstances.

If necessary, provide an adequate earthing connection for the workpiece.

Switch off unused devices.

**Dangers from the battery**



The substances contained in the battery used in this device can be harmful to the environment and to human and animal health.

If the device becomes damaged, please observe the following points:

- Make sure that leaking fluids cannot get into the soil or groundwater
- If pollution has already occurred, it must be removed in accordance with relevant national regulations



The battery can catch fire if overheated. Do not expose the device to heat (e.g. a permanent heat source or fire)

If the battery is damaged or subjected to improper use, dangerous vapours may be given off which can irritate the airways.

If this happens:

- Ensure an adequate supply of fresh air
- Seek medical attention in case of discomfort



With a faulty battery, liquid may leak out of the device.

- Avoid contact with the liquid
- Hand the device over to a Fronius Service Partner for repair
- Clean and check any parts that have come into contact with the liquid

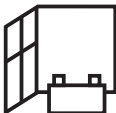

Do not operate or store the device in a potentially explosive atmosphere.

Special regulations apply in rooms at risk of fire or explosion.

Observe relevant national and international regulations.



---

To comply with European Directive 2006/66/EC on Batteries and Accumulators and its implementation in national law, batteries and rechargeable batteries that have reached the end of their life must be collected separately and returned to an approved recycling facility. Be sure to return any device that you no longer require to your dealer, or find out about the approved collection and recycling facilities in your area. Ignoring this European Directive may be harmful to the environment and your own health!

---

Devices with mechanically undamaged rechargeable batteries may be returned to the relevant Fronius Service Partner for repair or battery replacement.

As soon as it becomes evident that the rechargeable battery has been mechanically damaged (e.g. electrolyte is escaping), dispose of the device at your nearest recycling centre in accordance with national laws and guidelines. If anything is unclear or you have any questions about disposal, contact your Fronius Service Partner.

---

## Meandering welding currents



If the following instructions are ignored, meandering welding currents can develop with the following consequences:

- Fire hazard
  - Overheating of parts connected to the workpiece
  - Irreparable damage to ground conductors
  - Damage to device and other electrical equipment
- 

Ensure that the workpiece is held securely by the workpiece clamp.

Attach the workpiece clamp as close as possible to the area that is to be welded.

If the floor is electrically conductive, the device must be set up with sufficient insulating material to insulate it from the floor.

---

If distribution boards, twin-head mounts, etc., are being used, note the following: The electrode of the welding torch / electrode holder that is not used is also live. Make sure that the welding torch / electrode holder that is not used is kept sufficiently insulated.

---

## EMC measures



In certain cases, even though a device complies with the standard limit values for emissions, it may affect the application area for which it was designed (e.g. when there is sensitive equipment at the same location, or if the site where the device is installed is close to either radio or television receivers).

If this is the case, then the operator is obliged to take appropriate action to rectify the situation.

---

Check and evaluate the immunity to interference of nearby devices according to national and international regulations. Examples of equipment that may be susceptible to interference from the device include:

- Safety devices
  - Power, signal and data transfer lines
  - IT and telecommunications devices
  - Measuring and calibrating devices
- 

Supporting measures for avoidance of EMC problems:

### 1. Mains supply

- If electromagnetic interference arises despite correct mains connection, additional measures are necessary (e.g. use a suitable line filter).

2. Welding power leads
  - must be kept as short as possible
  - must run close together (to avoid EMF problems)
  - must be kept well apart from other leads
3. Equipotential bonding
4. Earthing of the workpiece
  - If necessary, establish an earth connection using suitable capacitors.
5. Shielding, if necessary
  - Shield off other nearby devices
  - Shield off entire welding installation

### EMF measures



Electromagnetic fields may pose as yet unknown risks to health:

- effects on the health of others in the vicinity, e.g. wearers of pacemakers and hearing aids
- wearers of pacemakers must seek advice from their doctor before approaching the device or any welding that is in progress
- for safety reasons, keep distances between the welding cables and the welder's head/torso as large as possible
- do not carry welding cables and hosepacks over the shoulders or wind them around any part of the body

### Factors affecting welding results

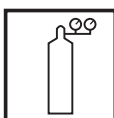

The following requirements with regard to shielding gas quality must be met if the welding system is to operate in a correct and safe manner:

- Size of solid matter particles < 40  $\mu\text{m}$
- Pressure dew point < -20 °C
- Max. oil content < 25 mg/m<sup>3</sup>

Filters must be used if necessary.



**NOTE!** There is an increased risk of soiling if ring mains are being used

### Danger from shielding gas cylinders



Shielding gas cylinders contain gas under pressure and can explode if damaged. As the shielding gas cylinders are part of the welding equipment, they must be handled with the greatest of care.

Protect shielding gas cylinders containing compressed gas from excessive heat, mechanical impact, slag, naked flames, sparks and arcs.

Mount the shielding gas cylinders vertically and secure according to instructions to prevent them falling over.

Keep the shielding gas cylinders well away from any welding or other electrical circuits.

Never hang a welding torch on a shielding gas cylinder.

Never touch a shielding gas cylinder with an electrode.

Risk of explosion - never attempt to weld a pressurised shielding gas cylinder.

Only use shielding gas cylinders suitable for the application in hand, along with the correct and appropriate accessories (regulator, hoses and fittings). Only use shielding gas cylinders and accessories that are in good condition.

Turn your face to one side when opening the valve of a shielding gas cylinder.

Close the shielding gas cylinder valve if no welding is taking place.

---

If the shielding gas cylinder is not connected, leave the valve cap in place on the cylinder.

---

The manufacturer's instructions must be observed as well as applicable national and international regulations for shielding gas cylinders and accessories.

---

### Danger from escaping shielding gas



Risk of suffocation from the uncontrolled escape of shielding gas

---

Shielding gas is colourless and odourless and, in the event of a leak, can displace the oxygen in the ambient air.

- Ensure an adequate supply of fresh air with a ventilation rate of at least 20 m<sup>3</sup>/hour.
  - Observe safety and maintenance instructions on the shielding gas cylinder or the main gas supply.
  - Close the shielding gas cylinder valve or main gas supply if no welding is taking place.
  - Check the shielding gas cylinder or main gas supply for uncontrolled gas leakage before every start-up.
- 

### Safety precautions in the place of use and for storage and transport

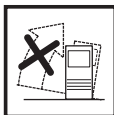

A toppling device can cause life-threatening injuries. Place the device on a solid, level surface so that it remains stable

- The maximum permissible tilt angle is 10°.
- 



Do not operate or store the device in a potentially explosive atmosphere.

Special regulations apply in rooms at risk of fire or explosion.

Observe relevant national and international regulations.

---

Use internal directives and checks to ensure that the workplace environment is always clean and clearly laid out.

---

Only set up and operate the device in accordance with the degree of protection shown on the rating plate.

---

When setting up the device, ensure there is an all-round clearance of 0.5 m (1 ft. 7.69 in.) to ensure that cooling air can flow in and out freely.

---

When transporting the device, observe the relevant national and local guidelines and accident prevention regulations. This applies especially to guidelines regarding the risks arising during transport.

---

After transporting the device, it must be visually inspected for damage before commissioning. Any damage must be repaired by trained service technicians before commissioning the device.

---



Odourless and colourless shielding gas may escape unnoticed if an adapter is used for the shielding gas connection. Prior to assembly, seal the device-side thread of the adapter for the shielding gas connection using suitable Teflon tape.

---

### Safety measures in normal operation



Only operate the device if all safety devices are fully functional. If the safety devices are not fully functional, there is a risk of

- injury or death to the operator or a third party,
  - damage to the device and other material assets belonging to the operator,
  - inefficient operation of the device.
- 

Any safety devices that are not functioning properly must be repaired before switching on the device.

---

---

Never bypass or disable safety devices.

Before switching on the device, ensure that no one is likely to be endangered.

Check the device at least once a week for obvious damage and proper functioning of safety devices.

---

## Safety inspection



The manufacturer recommends that a safety inspection of the device is performed at least once every 12 months.

The manufacturer recommends that the power source be calibrated during the same 12-month period.

A safety inspection should be carried out by a qualified electrician

- after any changes are made
- after any additional parts are installed, or after any conversions
- after repair, care and maintenance has been carried out
- at least every twelve months.

For safety inspections, follow the appropriate national and international standards and directives.

Further details on safety inspection and calibration can be obtained from your service centre. They will provide you on request with any documents you may require.

## Commissioning, maintenance and repair



It is impossible to guarantee that bought-in parts are designed and manufactured to meet the demands made of them, or that they satisfy safety requirements.

- Use only original spare and wearing parts (also applies to standard parts).
- Do not carry out any modifications, alterations, etc. to the device without the manufacturer's consent.
- Components that are not in perfect condition must be replaced immediately.
- When ordering, please give the exact designation and part number as shown in the spare parts list, as well as the serial number of your device.

The housing screws provide the ground conductor connection for earthing the housing parts.

Only use original housing screws in the correct number and tightened to the specified torque.

## Safety symbols



Devices with the CE mark satisfy the essential requirements of the low-voltage and electromagnetic compatibility directives (e.g. relevant product standards of the EN 60 974 series).

Fronius International GmbH hereby declares that the device is compliant with Directive 2014/53/EU. The full text on the EU Declaration of Conformity can be found at the following address: <http://www.fronius.com>



Devices marked with the CSA test mark satisfy the requirements of the relevant standards for Canada and the USA.

# Charger

---

## General



The device is manufactured using state-of-the-art technology and according to recognised safety standards. If used incorrectly or misused, however, it can cause:

- injury or death to the operator or a third party,
- damage to the device and other material assets belonging to the operating company,
- inefficient operation of the device.

---

All persons involved in commissioning, operating, maintaining and servicing the device must:

- be suitably qualified,
- read and follow these operating instructions carefully.

---

The operating instructions must always be at hand wherever the device is being used. In addition to the operating instructions, attention must also be paid to any generally applicable and local regulations regarding accident prevention and environmental protection.

---

All safety and danger notices on the device

- must be in a legible state,
- must not be damaged,
- must not be removed,
- must not be covered, pasted or painted over.

---

For the location of the safety and danger notices on the device, refer to the section headed "General information" in the operating instructions for the device.

Before switching on the device, rectify any faults that could compromise safety.

**This is for your personal safety!**

---

## Proper use



The device is to be used exclusively for its intended purpose. Any use above and beyond this purpose is deemed improper. The manufacturer is not liable for any damage, or unexpected or incorrect results arising out of such misuse.

---

Proper use includes:

- carefully reading and obeying all operating instructions and safety and danger notices
- performing all stipulated inspection and maintenance work
- following all instructions from the battery and vehicle manufacturers

---

Proper handling of the device is essential for it to function correctly. The device must never be pulled around by the cable.

---

## Mains connection

Devices with a higher rating may affect the energy quality of the mains due to their current consumption.

---

This may affect a number of types of device in terms of:

- connection restrictions
- criteria with regard to the maximum permissible mains impedance <sup>\*)</sup>
- criteria with regard to the minimum short-circuit power requirement <sup>\*)</sup>

<sup>\*)</sup> at the interface with the public grid  
see Technical Data

---

In this case, the plant operator or the person using the device should check whether the device may be connected, where appropriate by discussing the matter with the power supply company.

 **NOTE!** Ensure that the mains connection is earthed properly

**Dangers from mains current and charging current**



Anyone working with chargers exposes themselves to numerous dangers e.g.:

- risk of electrocution from mains current and charging current
- hazardous electromagnetic fields, which can risk the lives of those using cardiac pacemakers

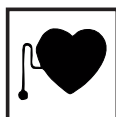

An electric shock can be fatal. Every electric shock is potentially life threatening. To avoid electric shocks while using the charger:

- do not touch any live parts inside or on the outside of the charger.
- do not short-circuit the charger lead

All cables and leads must be secured, undamaged, insulated and adequately dimensioned. Loose connections, scorched, damaged or inadequately dimensioned cables and leads must be immediately repaired by authorised personnel.

**Protecting yourself and others**



While the charger is in operation, keep all persons, especially children, out of the working area. If, however, there are people in the vicinity,

- warn them of all the dangers,
- provide suitable protective equipment.

Before leaving the work area, ensure that people or property cannot come to any harm in your absence.

**Safety measures in normal operation**



Chargers with a ground conductor must only be operated on a mains supply with a ground conductor and a socket with a ground conductor contact. If the charger is operated on a mains supply without a ground conductor or in a socket without a ground conductor contact, this will be deemed gross negligence. The manufacturer shall not be held liable for any damage arising from such usage.

- Only operate the charger in accordance with the degree of protection shown on the rating plate.
- Never operate the charger if there is any evidence of damage.
- Arrange for the mains cable to be checked regularly by a qualified electrician to ensure the ground conductor is functioning properly.
- Any safety devices and parts that are not functioning properly or are in imperfect condition must be repaired by a qualified technician before switching on the charger.
- Never bypass or disable protection devices.
- After installation, an accessible mains plug is required.

**EMC measures**



In certain cases, even though a device complies with the standard limit values for emissions, it may affect the application area for which it was designed (e.g. when there is sensitive equipment at the same location, or if the site where the device is installed is close to either radio or television receivers). If this is the case, then the operating company is obliged to take appropriate action to rectify the situation.



---

## Maintenance and repair



Under normal operating conditions, the device requires only a minimum of care and maintenance. However, it is vital to observe some important points to ensure it remains in a usable condition for many years.

- Before switching on, always check the mains plug and cable as well as charger leads and charging terminals for any signs of damage.
- If the surface of the device housing is dirty, clean with a soft cloth and solvent-free cleaning agent only

---

Maintenance and repair work must only be carried out by authorised personnel. Use only original replacement and wearing parts (also applies to standard parts). It is impossible to guarantee that bought-in parts are designed and manufactured to meet the demands made on them, or that they satisfy safety requirements.

---

Do not carry out any modifications, alterations, etc. to the device without the manufacturer's consent.

---

## Warranty and liability



The warranty period for the charger is 2 years from the date of invoice. However, the manufacturer will not accept any liability if the damage was caused by one or more of the following:

- Use of the charger "not in accordance with the intended purpose"
- Improper installation and operation
- Operating the charger with faulty protection devices
- Non-compliance with the operating instructions
- Unauthorised modifications to the charger
- Catastrophes caused by the activities of third parties and force majeure

---

## Safety inspection



The manufacturer recommends that a safety inspection of the device is performed at least once every 12 months.

---

A safety inspection should be carried out by a qualified electrician

- after any changes are made
- after any additional parts are installed, or after any conversions
- after repair, care and maintenance has been carried out
- at least every twelve months.

---

For safety inspections, follow the appropriate national and international standards and directives.

---

Further details on safety inspections can be obtained from your service centre. They will provide you on request with any documents you may require.

---

## Safety symbols



Devices with the CE mark satisfy the essential requirements of the low-voltage and electromagnetic compatibility directives.



Devices displaying this TÜV test mark satisfy the requirements of the relevant standards in Canada and USA.

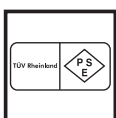

Devices displaying this TÜV test mark satisfy the requirements of the relevant standards in Japan.





Devices displaying this TÜV test mark and the mark on the rating plate satisfy the requirements of the relevant standards in Australia.



Devices displaying this EAC mark of conformity satisfy the requirements of the relevant standards in Russia, Belarus, Kazakhstan, Armenia and Kyrgyzstan.



**Power source**



## Device concept

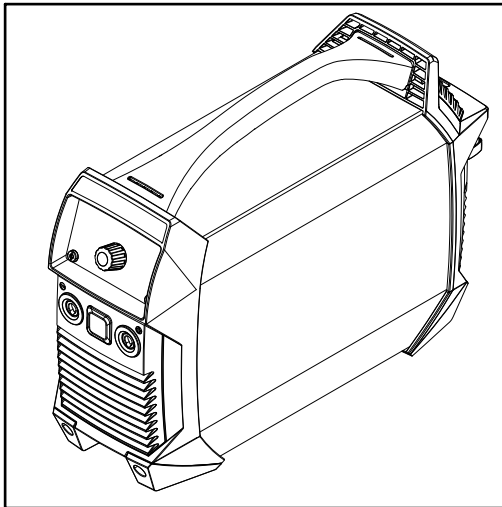

The power source has the following properties:

- Operation without mains electricity
- Compact dimensions
- Robust plastic housing
- Extremely reliable even under harsh operating conditions
- Carrying strap for easy transport on construction sites, etc.
- Protected controls
- Connection sockets with bayonet latch

During welding, an electronic regulator adapts the power source characteristic to suit the welding electrode. The result is a lightweight and compact device with excellent ignition and weld properties.

When cellulose electrodes (CEL) are used, a special operating mode can be selected to ensure perfect welding results.

TIG welding with touchdown ignition greatly extends the range of applications.

## Warning notices on the device

The warning notices and safety symbols on the power source must not be removed or painted over. They warn against incorrect operation which can lead to serious injury and damage.

### Meaning of safety symbols on the device:



Risk of serious injury and damage due to incorrect operation.



Do not use the functions described here until you have fully read and understood the following documents:

- these operating instructions
- all the operating instructions for the system components of the power source, especially the safety rules



Do not dispose of used devices with domestic waste. Dispose of them according to the safety rules.

**Application areas**

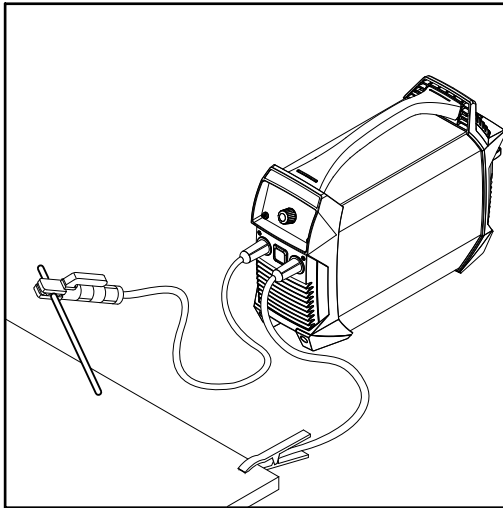

*MMA welding*

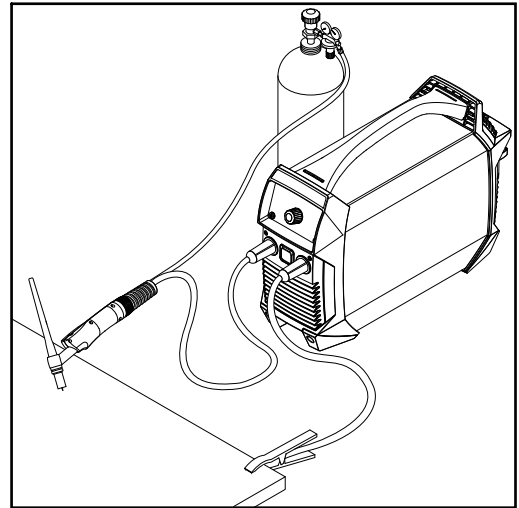

*TIG welding with gas-valve torch*

# Using rechargeable devices

## Safety



### WARNING!

#### Improper handling of batteries can cause injuries or damage.

The power source is operated using a lithium-ion rechargeable battery pack.

Note the following points without exception:

- ▶ Never expose the power source to naked flames. Excessive heat can cause the battery to explode or burst.
- ▶ Do not open the power source or remove the battery. If the battery becomes damaged due to improper handling, poisonous substances can escape which may be harmful to health.
- ▶ Do not drop the power source into water. This can cause a short circuit, even if the power source is switched off. This in turn can cause the battery to become hot, ignite or burst.



### WARNING!

#### Improper handling can cause injuries or damage.

Do not open the power source.

The power source may only be opened by a Fronius service engineer.

If you need a replacement battery, hand the power source over to a Fronius Service Partner.

## Storage and transport

When storing or transporting the power source, observe the environmental conditions in the **Technical data** section on page 61.

Particularly if the power source is stored for long periods of time, observe the following points:

- Only store the power source when it is fully charged
- Optimum storage temperature: +20 °C (+68 °F)
- Fully charge the power source at least every six months

When transporting the power source, observe the relevant national guidelines.

Note the following safety data for transport:

- Dangerous goods class: 9
- Classification code: M4
- Packaging group: II

## Service life of the battery

### NOTE!

#### The service life of the battery is dependent entirely upon how it is handled.

The way in which the battery is operated and stored and the conditions under which this occurs are therefore extremely important.

The intelligent functions of the power source (see the **Battery protection functions** section on page 33) play a significant role in increasing the service life of the battery.

However, the user must observe the following key points in order to guarantee maximum battery life:

- Recharge the battery after every discharge  
Do not wait until the battery is completely discharged before recharging it.
  
- Protect the power source from extreme influences  
Optimum environmental conditions for operation and storage:
  - Temperature: +15 °C to +25 °C (+59 °F to +77 °F)
  - Humidity: 50%
  - Surrounding air is free from dust and corrosive vapours or gases
  
- If the power source is left idle, charge it on a regular basis
  
- Fully charge the power source at least every 6 months.



# Battery protection functions

---

## General



The battery protection functions serve to:

- increase the service life of the battery
  - protect the battery from long-term damage
  - increase the reliability of the power source
- 

## Deep discharge protector

The power source has a deep discharge protector to warn the user if the state of charge of the battery is too low. If this is the case, the power source switches off.

Function of the deep discharge protector:

- when the battery capacity is exhausted
  -  all segments of the battery capacity indicator flash
  -  "Lo" is shown on the display
  - welding is no longer possible
- the power source switches off automatically after three minutes



### CAUTION!

**Storing the battery for longer periods in a discharged state may damage the battery.**

If the deep discharge protector is triggered, charge the power source immediately.

---

## Automatic switch-off

Automatic switch-off avoids unnecessary power consumption, thereby extending the effective period of operation with one battery charge.

If the power source is not operated for a specific length of time, it switches off automatically.

To reactivate the power source, press the On/Off button for at least two seconds.

### NOTE!

**The factory setting for the automatic switch-off time is 15 minutes (if no welding is performed for 15 minutes, the power source switches off automatically).**

This value can be changed in the Setup menu using the tSd parameter.

---

---

## Temperature monitoring

Temperature monitoring prevents the battery from being charged or discharged if the temperature of the battery is outside the permitted temperature range.

### Undertemperature:

If the battery falls below the permitted temperature range, neither welding nor charging is possible.

If the battery is charged, it can be heated until welding is possible. To do this, proceed as follows:

- 1** Attempt to start welding
  - if the battery is still too cold, welding is not possible
  - the temperature indicator lights up and „cold“ appears on the display
  - both indicators go out after approx. five seconds
- 2** Attempt to start welding again after approx. five seconds
  - if the battery is still too cold, welding is not possible
  - the temperature indicator lights up and „cold“ appears on the display
  - both indicators go out after approx. five seconds
- 3** Repeat the procedure until the battery reaches the required operating temperature (through multiple attempts to start welding)

Charging is only possible again at a temperature of -10 °C.

### Overtemperature:

If the battery exceeds the permitted temperature range:

- the temperature indicator lights up and „hot“ is shown on the display
- neither welding nor charging is possible until the temperature indicator goes out (when the battery has cooled down)

---

## Overcharging protection

Once the battery has been fully charged, the charger turns off automatically and switches to conservation charging mode.

In this mode the power source can remain connected to the charger for any length of time.

More information on how the charger and the individual operating modes work can be found in the charger description on page [63](#).

# Before commissioning

## Safety



### WARNING!

**Incorrect operation or shoddy workmanship can cause serious injury or damage.**

All activities described in these operating instructions may only be carried out by trained and qualified personnel. All functions described in these operating instructions may only be used by trained and qualified personnel. Do not carry out any of the work or use any of the functions described until you have fully read and understood the following documents:

- ▶ these operating instructions
- ▶ all the operating instructions for the system components, especially the safety rules

## Proper use

The power source is intended exclusively for MMA welding and TIG welding. The integrated battery must only be charged with the Fronius ActiveCharger 1000. Any other use is deemed improper. The manufacturer is not liable for damage resulting from such use.

Proper use also includes:

- carefully reading these operating instructions
- following all the instructions and safety rules in these operating instructions
- performing all stipulated inspection and maintenance work

## Setup regulations



### WARNING!

**Toppling or falling devices can cause life-threatening injuries.**

Place devices on a solid, level surface so that they remain stable.

The device is tested to IP 23 protection, meaning:

- protection against penetration by solid foreign bodies with diameters > 12.5 mm (0.49 in.)
- protection against direct sprays of water at any angle up to 60° from the vertical

### Cooling air

The device must be set up in such a way that cooling air can flow freely through the slots in the front and rear panels.

### Dust

Ensure that metallic dust is not sucked into the system by the fan, when carrying out grinding for example.

### Outdoor operation

The device can be set up and operated outdoors in accordance with IP23 degree of protection. Avoid direct wetting (e.g. from rain).

## Power connection

The device is designed to be connected to the mains using the Fronius ActiveCharger 1000 only (= hybrid mode, see [Hybrid mode](#) on page 71).

**NOTE!**

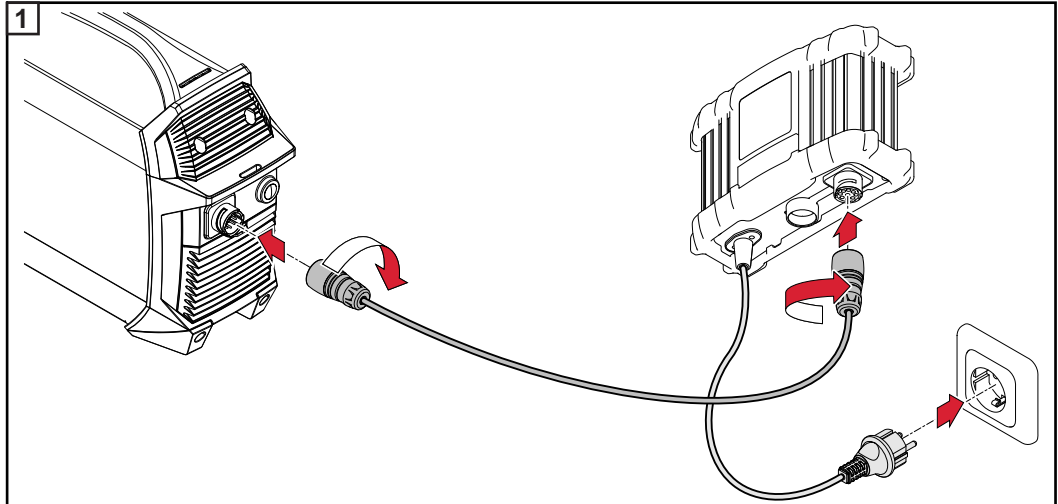

No warranty claims will be entertained if the device is operated with other chargers.

**Before starting  
for the first time**



-  Once connected, the battery capacity indicator on the power source flashes to indicate the current state of charge; the battery is being charged

If the battery is fully charged:

-  The COMPLETED indicator lights up on the charger
-  On the power source, all segments of the battery capacity indicator are lit
- The power source can be put into operation

# Control elements and connections

---

## Safety



### WARNING!

**Operating the equipment incorrectly can cause serious injury and damage.**

Do not use the functions described until you have thoroughly read and understood the following documents:

- ▶ these operating instructions
  - ▶ all the operating instructions for the system components, especially the safety rules
- 

### NOTE!

**Due to software updates, you may find that your device has certain functions that are not described in these operating instructions or vice versa.**

Individual illustrations may also differ slightly from the actual controls on your device, but these controls function in exactly the same way.

---

## Connections and mechanical components

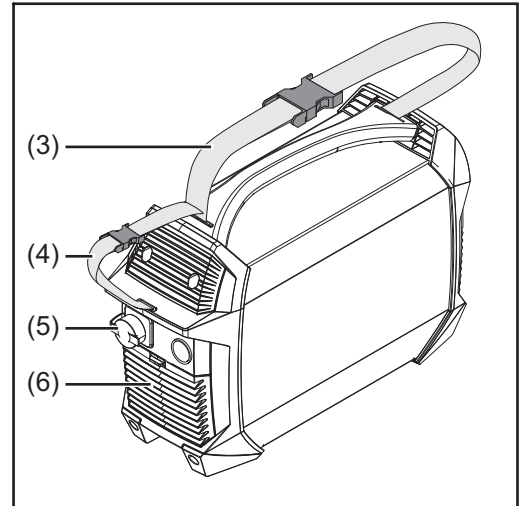
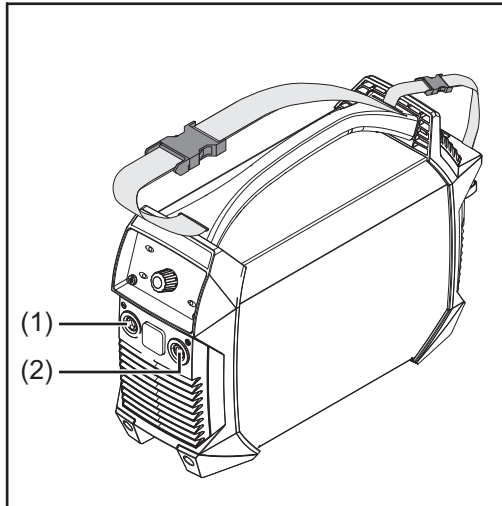

---

(1) **(-) current socket**  
with bayonet latch

---

(2) **(+) current socket**  
with bayonet latch

---

(3) **Carrying strap**

---

(4) **Cable strap**  
for holding the mains cable and the welding power-leads  
Do not use to move the device!

---

(5) **Charger connection**

---

(6) **Air filter**

---



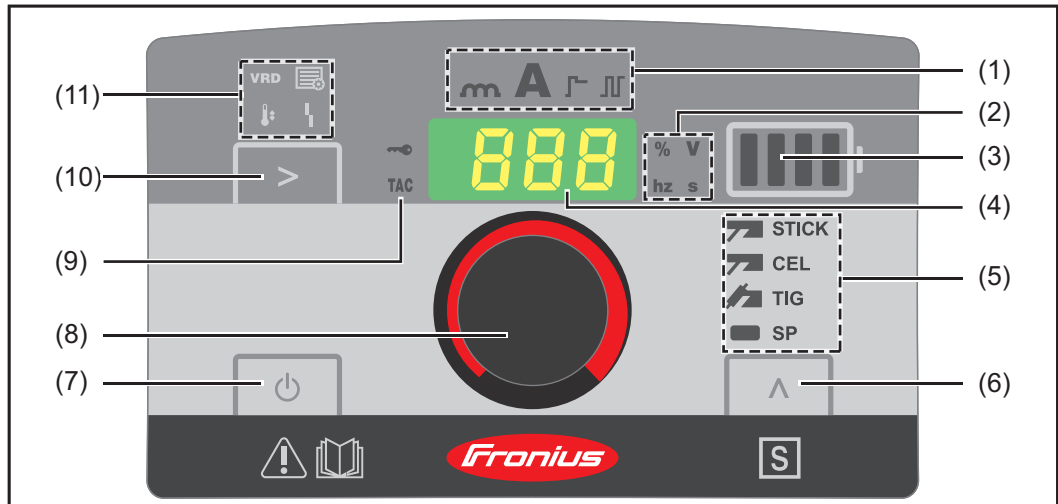

The use of the current connections depends on the welding process:

- MMA welding (depending on electrode type)
  - (+) current socket** for electrode holder or grounding cable
  - (-) current socket** for electrode holder or grounding cable
- TIG welding
  - (+) current socket** for grounding cable
  - (-) current socket** for welding torch

## Control panel



- (1) **Setting value indicator**  
shows which setting value is selected:
- Arc-force dynamic
  - Welding current
  - SoftStart / HotStart function
  - TIG pulsing (only enabled on TIG version)
- 
- (2) **Unit indicator**  
shows the unit of the value that is currently being changed using the adjusting dial (8):
- Percent
  - Voltage (volts)
  - Frequency (Hertz)
  - Time (seconds)
- 
- (3) **Battery capacity indicator**  
shows the state of charge of the battery:
- Battery fully charged
  - Battery capacity 75%
  - Battery capacity 50%
  - Battery capacity 25%
  - Battery discharged  $\Rightarrow$  **Charge the battery now!**
- shows the operating mode:
- lights up in the following situations:
    - Pure welding mode
    - Conservation charging mode
  - a bar also flashes in the following operating modes:
    - Charging
    - Quick charging
    - Hybrid mode
- 
- (4) **Display**
- 
- (5) **Welding process indicator**  
shows which welding process is selected:
- STICK MMA welding
  - CEL MMA welding with Cel electrode
  - TIG TIG welding
  - SP Reserved for special programs
- 
- (6) **Welding process button**  
for selecting the welding process

- 
- (7) **On/Off button**  
for switching the power source on and off.  
The button must be pressed for at least two seconds before it responds (to protect against accidental operation)
- 
- (8) **Adjusting dial**
- 
- (9) **TAC indicator**  
lights up when the tacking function is activated  
(only on TIG devices during the TIG welding process)
- 
- (10) **Setting value button**  
for selecting the desired setting value (1)
- 
- (11) **Status indicators**  
display various operating modes of the power source:
-  **VRD** - lights up if the (optional) VRD safety device is present and the reduced safety voltage is present at the welding sockets
  -  **Setup** - lights up in Setup mode
  -  **Temperature** - power source outside the permitted temperature range
  -  **Error** - see [Troubleshooting](#) section on page [56](#)
-











# MMA welding



## Preparatory work

-  Press the On/Off button for at least two seconds to turn off the power source
  - the indicators go out
-  Plug the grounding cable into the (+) or (-) current socket depending on which type of electrode is to be used and turn it clockwise to latch it in place
-  Use the other end of the grounding cable to establish a connection to the workpiece
-  Plug the electrode holder into the (+) or (-) current socket depending on which type of electrode is to be used and turn it clockwise to latch it in place
-  Insert the rod electrode into the electrode holder







### CAUTION!

#### Risk of injury and damage from electric shock.

As soon as the power source is switched on, the electrode in the electrode holder is live. Make sure the electrode does not touch any persons or electrically conductive or earthed parts (e.g. the housing, etc.).

-  Press the On/Off button for at least two seconds to turn on the power source
  -  the welding current indicator lights up
  - the display shows the specified welding current

## MMA welding

-  Use the welding process button to select one of the following processes:
  -  **STICK** MMA welding - the MMA welding indicator lights up after selection
  -  **CEL** MMA welding with Cel electrode - the MMA welding with Cel electrode indicator lights up after selection
-  Press the setting value button until  the welding current indicator lights up
-  Select the amperage using the adjusting dial
  - Power source is ready for welding

## SoftStart / Hot-Start function

This function is used to set the starting current.

**Setting range:** 0 - 200%



#### Operating principle:

At the start of the welding process, the welding current is reduced (SoftStart) or increased (HotStart) for 0.5 seconds, depending on the setting.

The change is shown as a percentage from the set welding current.

The duration of the starting current can be changed in the Setup menu using the Hti parameter, see [Starting current duration](#) on page 50.

#### Setting the starting current:

-  Press the setting value button until  the SoftStart / HotStart indicator lights up

- 2  Turn the adjusting dial until the desired value is reached

- Power source is ready for welding

### NOTE!

The maximum HotStart current is limited to 180 A.

#### Examples:

(set welding current = 100 A)

- 100%  $\Rightarrow$  Starting current = 100 A  $\Rightarrow$  Function deactivated
- 80%  $\Rightarrow$  Starting current = 80 A  $\Rightarrow$  SoftStart
- 135%  $\Rightarrow$  Starting current = 135 A  $\Rightarrow$  HotStart
- 200%  $\Rightarrow$  Starting current = 180 A  $\Rightarrow$  HotStart (maximum current limit reached!)

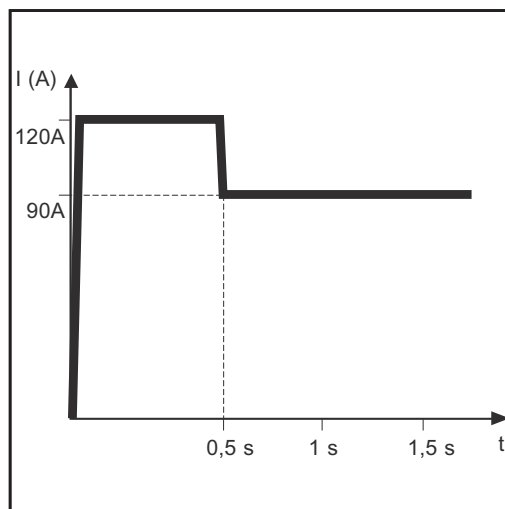

Example of HotStart function

#### Features of SoftStart function:

- Reduced pore formation with certain electrode types

#### Features of HotStart function:

- Improved ignition properties, even when using electrodes with poor ignition properties
- Better fusion of the base material during the start-up phase, meaning fewer cold-shut defects
- Largely prevents slag inclusions

## Arc-force dynamic

To obtain optimum welding results, it will sometimes be necessary to adjust the arc-force dynamic.



**Setting range:** 0 - 100 (corresponds to 0 - 200 A current increase)

#### Operating principle:

At the moment of droplet transfer or in the event of a short circuit, the amperage is briefly increased in order to obtain a stable arc.

If the rod electrode threatens to sink into the weld pool, this measure prevents the weld pool solidifying, as well as preventing a prolonged short-circuit of the arc. This largely prevents the rod electrode from sticking.

#### Setting the arc-force dynamic:

- 1  Press the setting value button until the arc-force dynamic indicator lights up
- 2  Turn the adjusting dial until the desired correction value is reached
- Power source is ready for welding

**NOTE!**

The maximum arc-force dynamic current is limited to 180 A.

---

**Examples:**

- Arc-force dynamic = 0
  - arc-force dynamic deactivated
  - soft, low-spatter arc
- Arc-force dynamic = 20
  - arc-force dynamic with 40 A current increase
  - harder, more stable arc
- Set welding current = 100 A / arc-force dynamic = 60
  - arc-force dynamic theoretically with 120 A current increase
  - actual increase is just 80 A as the maximum current limit has been reached!

# TIG welding

## General

### NOTE!

Do not use pure tungsten electrodes (colour-coded green) if the TIG welding process has been selected.

## Connecting the gas cylinder



### WARNING!

There is a high risk of very serious injury and damage if a gas cylinder falls over. Place gas cylinders on a solid, level surface so that they remain stable. Secure gas cylinders to prevent them from falling over.

Observe the safety rules of the gas cylinder manufacturer.

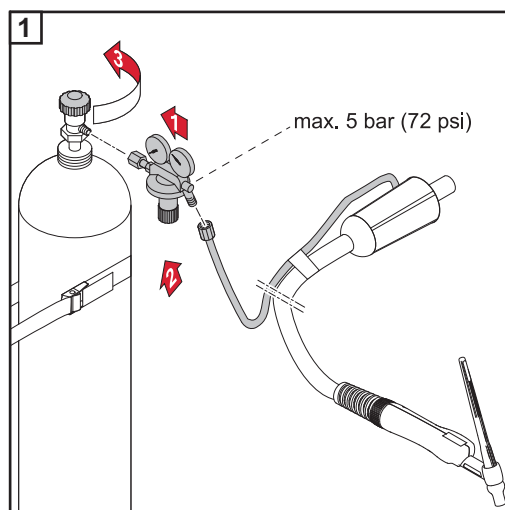

## Preparatory work



- 1  Press the On/Off button for at least two seconds to turn off the power source  
- the indicators go out
- 2 Plug the TIG welding torch into the (-) current socket and turn it clockwise to latch it in place
- 3 Set up the welding torch in accordance with the welding torch operating instructions
- 4 Plug the grounding cable into the (+) current socket and turn it clockwise to latch it in place
- 5 Use the other end of the grounding cable to establish a connection to the workpiece



### CAUTION!

**Risk of injury and damage from electric shock.**

As soon as the power source is switched on, the electrode in the welding torch is live. Make sure the electrode does not touch any persons or electrically conductive or earthed parts (e.g. the housing, etc.).

- 6  Press the On/Off button for at least two seconds to turn on the power source  
-  the welding current indicator lights up  
- the display shows the specified welding current



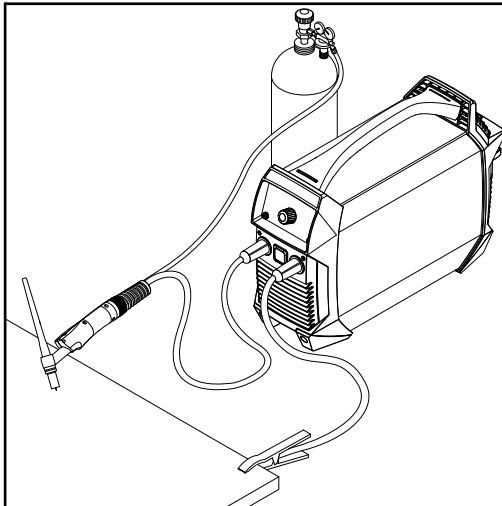

**Setting the gas pressure**



Welding torch with gas cut-off valve

- 1 Open the gas cut-off valve of the welding torch  
– Shielding gas flows
- 2 Set the desired gas flow rate on the pressure regulator
- 3 Close the gas cut-off valve of the welding torch

**TIG welding**

- 1  Select TIG welding with the welding process button  
 the TIG welding indicator lights up
- 2  Press the setting value button until  
 the welding current indicator lights up
- 3  Adjust the welding current using the adjusting dial
- 4 Place the gas nozzle down on the ignition location, ensuring there is a gap of approx. 2 to 3 mm (5/64 to 1/8 in.) between the tungsten electrode and the workpiece Gap exists
- 5 Actuate gas cut-off valve  
– Shielding gas flows
- 6 Gradually tilt the welding torch up until the tungsten electrode touches the workpiece
- 7 Raise the welding torch and rotate it into its normal position  
– The arc ignites
- 8 Carry out welding

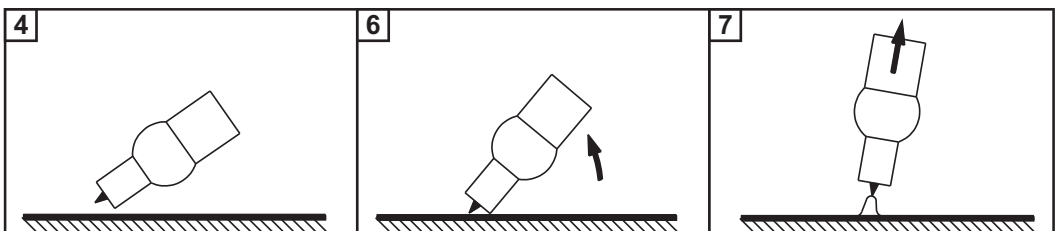

**TIG Comfort Stop** For more information on activating and setting the TIG Comfort Stop function, see **Comfort Stop Sensitivity** on page 51.

**Function and application of TIG Comfort Stop:**

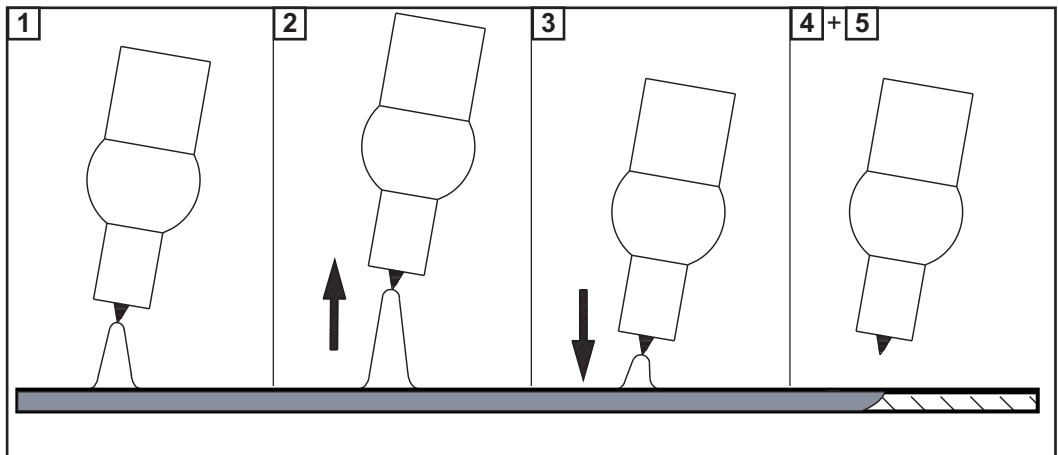

- 1** Welding
- 2** During welding, raise the welding torch
  - The arc length is increased significantly
- 3** Lower the welding torch
  - The arc length is decreased significantly
  - This triggers the TIG Comfort Stop function
- 4** Keep the welding torch at the same height
  - The welding current continually decreases (downslope) until the arc goes out
- 5** Wait for the gas post-flow time to finish and lift the welding torch away from the work-piece



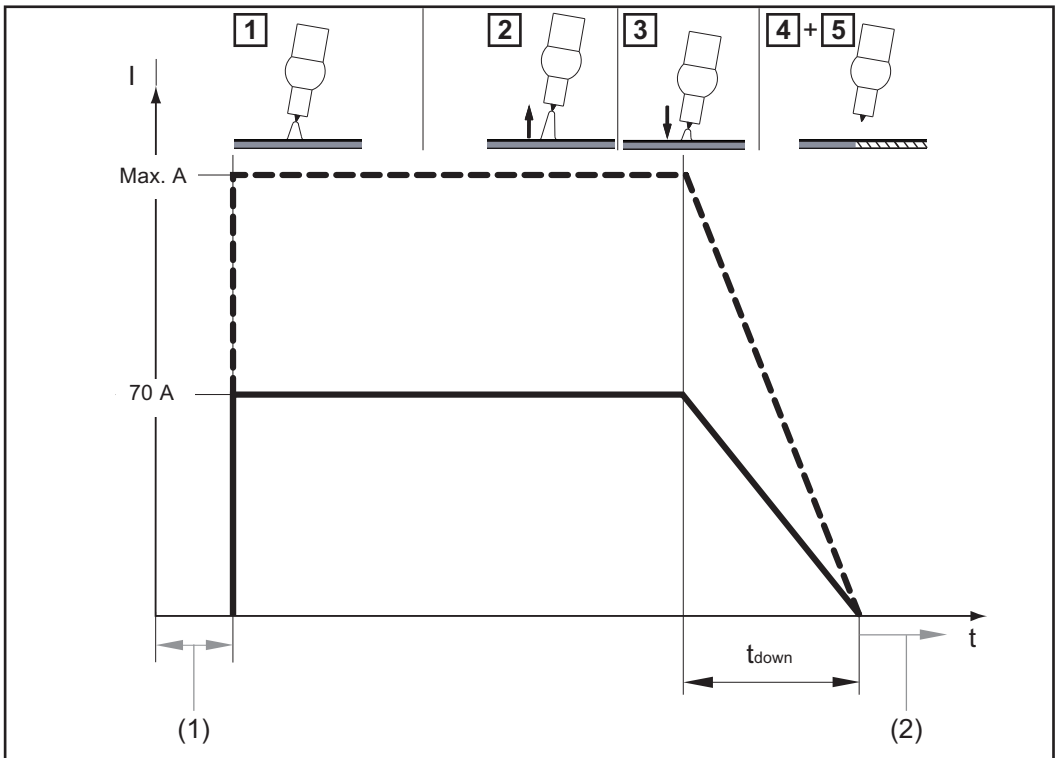

Welding current and gas flow curve with TIG Comfort Stop function activated

- (1) Gas pre-flow
- (2) Gas post-flow

**Downslope:**

The downslope time  $t_{down}$  is 0.5 seconds and cannot be adjusted.

**Gas post-flow:**

The gas post-flow must be carried out manually.

# The Setup menu



## Accessing the Setup menu

- 1  Use the welding process button to select the process for which the Setup parameters are to be changed:





 **STICK** MMA welding

 **CEL** MMA welding with Cel electrode



 **TIG** TIG welding

- 2  +  Press the setting value and welding process buttons together
  - After releasing the buttons, the code for the first parameter in the Setup menu is displayed



## Changing welding parameters





- 1  Turn the adjusting dial to select the required parameter
- 2  Press the adjusting dial to display the preset value of the parameter
- 3  Turn the adjusting dial to change the value
  - The new value becomes effective immediately
  - Exception: when restoring the factory settings, press the adjusting dial after changing the value to activate the new value.
- 4  Press the adjusting dial to return to the list of parameters

## Exiting the Setup menu



- 1  Press the setting value or  welding process button to exit the Setup menu





## Parameters for MMA welding

Parameter	Description	Range	Unit
	<b>Starting current duration</b> For the SoftStart / HotStart function Factory setting: 0.5 seconds	0.1 - 1.5	Seconds
	<b>Anti-stick</b> When the anti-stick function is active, the arc is extinguished after 1.5 seconds in the event of a short circuit (sticking of the electrode) Factory setting: ON (activated)		On OFF

Parameter	Description	Range	Unit
	<b>Break voltage (U cut off)</b> Used to specify at which arc length the welding process is to be completed. The welding voltage increases as the length of the arc increases. The arc is extinguished when it reaches the voltage specified here.  Factory setting: 45 volts	25 - 80	Volts
	<b>Software version</b> The full version number of the currently installed software is spread across a number of displays and can be retrieved by turning the adjusting dial.		
	<b>Automatic switch-off (time Shut down)</b> If the power source is not operated for the specified length of time, it switches off automatically.  Factory setting: 900 seconds	300 - 900	Seconds OFF
	<b>Factory setting (FACTory)</b> The power source can be reset to its factory settings here.  <ul style="list-style-type: none"> <li>- Cancel reset <span style="float: right;">no</span></li> <li>- Reset the parameters for the selected welding process to their factory settings <span style="float: right;">YES</span></li> <li>- Reset the parameters for all welding processes to their factory settings <span style="float: right;">ALL</span></li> </ul>  Resetting of the selected value to its factory setting must be confirmed by pressing the adjusting dial.		

**Parameters for TIG welding**

Parameter	Description	Range	Unit
	<b>Comfort Stop Sensitivity</b> Factory setting: 0.5  For details see the <b>TIG Comfort Stop</b> section on page 48	0.3 - 2.0	Volts OFF
	<b>Break voltage (U cut off)</b> Used to specify at which arc length the welding process is to be completed. The welding voltage increases as the length of the arc increases. The arc is extinguished when it reaches the voltage specified here.  This parameter is only available when the <b>CSS</b> parameter is set to OFF.  Factory setting: 15 volts	12 - 35	Volts

Parameter	Description	Range	Unit
	<b>Software version</b> The full version number of the currently installed software is spread across a number of displays and can be retrieved by turning the adjusting dial.		
	<b>Automatic switch-off (time Shut down)</b> If the power source is not operated for the specified length of time, it switches off automatically.  Factory setting: 900 seconds	300 - 900	Seconds OFF
	<b>Factory setting (FACTory)</b> The power source can be reset to its factory settings here.		
	<ul style="list-style-type: none"> <li>- Cancel reset</li> <li>- Reset the parameters for the selected welding process to their factory settings</li> <li>- Reset the parameters for all welding processes to their factory settings</li> </ul>		no YES ALL
	Resetting of the selected value to its factory setting must be confirmed by pressing the adjusting dial.		

# VRD safety device (optional)

## General

VRD is an additional safety device that prevents, as far as possible, output voltages that may pose a danger to persons.

VRD = Voltage Reduction Device.

## Function

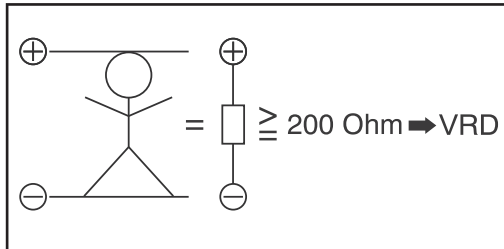

VRD is active

The welding circuit resistance is greater than the minimum human body resistance (greater than or equal to 200 Ohm):

- VRD is active
- Open circuit voltage is limited to 14 V
- **VRD** The VRD indicator lights up
- **Example:** no risk ensues if both welding sockets are touched accidentally at the same time.

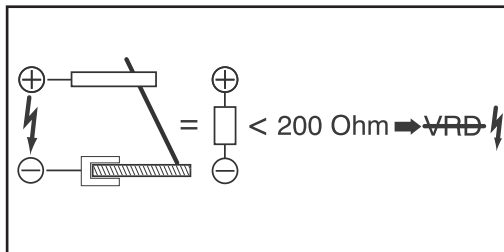

VRD is not active

The welding circuit resistance is less than the minimum human body resistance (less than 200 Ohm):

- VRD is inactive
- Output voltage not limited in order to ensure sufficient welding power
- The VRD indicator does not light up
- **Example:** Start of welding

### NOTE!

#### Within 0.

3 seconds of the end of welding:

- ▶ VRD is active again
- ▶ The output voltage is limited to 14 V again

# Care, maintenance and disposal

---

## Safety



### WARNING!

**Work that is carried out incorrectly can cause serious injury or damage.**

All the work described below must only be carried out by trained and qualified personnel. Do not carry out any of the work described below until you have fully read and understood the following documents:

- ▶ this document
  - ▶ all the operating instructions for the system components, especially the safety rules
- 



### WARNING!

**An electric shock can be fatal.**

Before starting the work described below:

- ▶ Turn the power source mains switch to the "O" position
  - ▶ Disconnect the power source from the mains
  - ▶ ensure that the power source remains disconnected from the mains until all work has been completed
- 



### WARNING!

**Improper handling can cause injuries or damage.**

Do not open the power source.

The power source may only be opened by a Fronius service engineer.

If you need a replacement battery, hand the power source over to a Fronius Service Partner.

---

## General

Under normal operating conditions, the device requires only a minimum of care and maintenance. However, it is vital to observe some important points to ensure the device remains in a usable condition for many years.

---

## At every start-up

- Check the charging lead, welding torch/electrode holder, welding power-lead and grounding (earthing) connection for damage. Replace any damaged components
- Check that there is an all-round clearance of 0.5 m (1 ft. 8 in.) around the power source to ensure that cooling air can flow in and out freely

### NOTE!

**Air inlets and outlets must never be covered, not even partially.**

---

Every 2 months

Clean the air filter (if fitted):

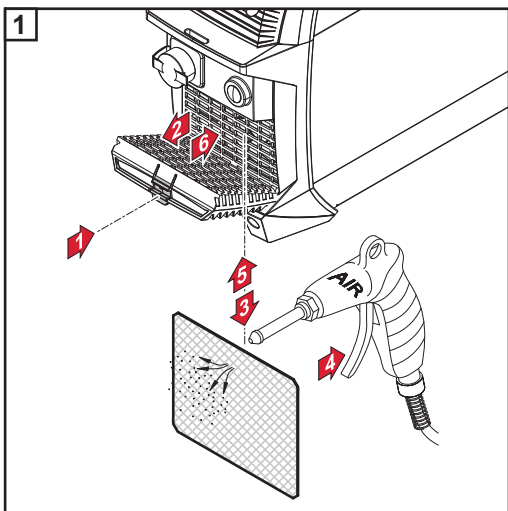

Disposal

Dispose of in accordance with the applicable national and local regulations.

# Troubleshooting

---

## Safety



### WARNING!

**Work that is carried out incorrectly can cause serious injury or damage.**

All the work described below must only be carried out by trained and qualified personnel. Do not carry out any of the work described below until you have fully read and understood the following documents:

- ▶ this document
  - ▶ all the operating instructions for the system components, especially the safety rules
- 



### WARNING!

**An electric shock can be fatal.**

Before starting the work described below:

- ▶ Turn the power source mains switch to the "O" position
  - ▶ Disconnect the power source from the mains
  - ▶ ensure that the power source remains disconnected from the mains until all work has been completed
- 



### WARNING!

**Improper handling can cause injuries or damage.**

Do not open the power source.

The power source may only be opened by a Fronius service engineer.

If you need a replacement battery, hand the power source over to a Fronius Service Partner.

---

---

## Indicated errors

### Overtemperature

"hot" appears on the display, the temperature indicator lights up



Cause: Device is too hot

Remedy: Check/reduce ambient temperature, allow power source to cool down

---

### Undertemperature

"cold" appears as scrolling text on the display, the temperature indicator lights up



Cause: Device temperature too low

Remedy: Check/increase ambient temperature, operate the power source in a warmer environment

---

For more information see the [Operating environments](#) section on page 61

---



### Deep discharge protection

"Lo" appears in the display, the "Battery capacity" indicator flashes



Cause: Battery discharged, deep discharge protection has been activated

Remedy: Charge the battery now

 Battery operation is possible again above 25% capacity

### CAUTION!

**Deep discharge can destroy the battery.**

Do not store the battery when it is in this state

### Service messages

When E and a 2 digit error number appear in the display (e.g. E02) and the "Error" indicator lights up, this is an internal power source service code.

Example: 

 It is also possible that several error numbers are present. These appear when turning the adjusting dial.

Make a note of the error numbers shown in the display, and of the serial number and configuration of the power source, and contact our after-sales service team with a detailed description of the error.

#### **E02 / E03 / E05 / E06**

Cause: Internal temperature sensor fault on ACCUPLT / ACCUPLT-TIG PC board

Remedy: Contact after-sales service

#### **E07**

Cause: 15 V supply voltage too low

Remedy: Contact after-sales service

#### **E09 / E10**

Cause: Load too high on power source current sockets

Remedy: Use power source correctly (welding)

#### **E11**

Cause: No communication with the control panel

Remedy: Contact after-sales service

#### **E12 / E13 / E14**

Cause: Internal error on ACCUPLT / ACCUPLT-TIG PC board

Remedy: Contact after-sales service

#### **E16**

Cause: Communication error between battery and ACCUPLT / ACCUPLT-TIG PC board

Remedy: Contact after-sales service

**E18**

Cause: Wrong firmware (software) has been loaded

Remedy: Contact after-sales service

**E19 / E22**

Cause: Battery fault

Remedy: Contact after-sales service

**E23**

Cause: A voltage of &gt; 113 V DC has been measured on the current sockets

Remedy: Contact After-Sales Service

**No function****The power source cannot be switched on**

Cause: The battery has entered a state of deep discharge as it has been stored for too long without being charged

Remedy: Charge the battery now

 Battery operation is possible again above 25% capacity. If charging is no longer possible, contact After-Sales Service.

Cause: Control panel defective

Remedy: Contact After-Sales Service

**Battery is not charged**

Power source is connected to the charger, charger is connected to the mains, no charging indicator on the power source

Cause: Device is too hot

Remedy: Check/reduce ambient temperature, allow battery to cool down

Cause: Device temperature too low

Remedy: Check/increase ambient temperature

**No welding current**

Power source is switched on, indicator for the selected welding process is lit

Cause: Welding power-lead connections have been disconnected

Remedy: Establish proper welding power-lead connections

Cause: Poor or no earth

Remedy: Establish a connection to the workpiece

Cause: There is a break in the power cable in the welding torch or electrode holder

Remedy: Replace welding torch or electrode holder

**No welding current**

Power source is switched on, indicator for the selected welding process is lit, overtemperature indicator lit

Cause: Duty cycle exceeded - power source overloaded - fan running

Remedy: Keep within duty cycle

Cause: Thermostatic automatic circuit breaker has been tripped

Remedy: Wait until the power source comes back on automatically at the end of the cooling phase

Cause: The fan in the power source is faulty

Remedy: Contact After-Sales Service

Cause: Insufficient cooling air intake

Remedy: Ensure adequate air supply

Cause: Air filter is dirty

Remedy: Clean air filter

**No welding current**

Power source is switched on, indicator for the selected welding process is lit, overtemperature indicator lit

Cause: Power module error

Remedy: Turn off the power source, then turn it on again.  
If the error occurs frequently, contact After-Sales Service

**Faulty operation****Poor ignition properties during MMA welding**

Cause: Incorrect welding process selected

Remedy: Select "MMA welding" or "MMA welding with Cel electrode" process

Cause: Starting current too low; electrode sticking during ignition

Remedy: Increase starting current using HotStart function

Cause: Starting current too high; electrode consumed too quickly during ignition or is generating a lot of spatter

Remedy: Reduce starting current using SoftStart function

**In some cases, arc breaks during welding**

Cause: Electrode (e.g. grooved electrode) voltage too high

Remedy: If possible, use alternative electrode or a power source with more welding power

Cause: Break voltage (Uco) set too low

Remedy: Increase break voltage (Uco) in Setup menu

**Rod electrode tends to stick**

Cause: Value of arc-force dynamic parameter (MMA welding) set too low

Remedy: Increase value of arc-force dynamic parameter

### **Poor weld properties**

(severe spattering)

Cause: Incorrect electrode polarity

Remedy: Reverse electrode polarity (refer to manufacturer's instructions)

Cause: Poor grounding (earthing) connection

Remedy: Fasten earthing clamps directly to workpiece

Cause: Setup parameters not ideal for selected welding process

Remedy: Select the optimal settings in the Setup menu for the selected welding process

---

### **Tungsten electrode melting**

Tungsten inclusions in base metal during the ignition phase

Cause: Incorrect tungsten electrode polarity

Remedy: Connect the TIG welding torch to the (-) current socket

Cause: Incorrect (or no) shielding gas

Remedy: Use inert shielding gas (argon)

---

### **VRD does not light up even though no welding process is taking place**

Cause: VRD option not present  
or internal device fault

Remedy: Contact after-sales service

---

# Technical data

## Operating environments



Transport, storage or operation of the charger outside the stipulated area will be deemed improper. The manufacturer shall not be held liable for any damage arising from such usage.

Ambient temperature range:

- during operation: -10 °C to +40 °C (14 °F to 104 °F)
- during transport and storage: -20 °C to +55 °C (-4 °F to 131 °F)
- recommended temperature range during charging: + 4 °C to + 40 °C (+ 39,2 °F to + 104 °F)

Relative humidity:

- up to 50 % at 40 °C (104 °F)
- up to 90 % at 20 °C (68 °F)

The surrounding air must be free from dust, acids, corrosive gases or substances, etc.

Can be used at altitudes up to 2000 m (6561 ft.)

## Explanation of the term "duty cycle"

Duty cycle (D.C.) is the proportion of time in a 10-minute cycle at which the device may be operated at its rated output without overheating.

### NOTE!

#### The D.C.

C. values specified on the rating plate are based on an ambient temperature of 40°C. If the ambient temperature is higher, either the D.C. or output must be reduced accordingly.

Example: Welding at 150 A at 60% D.C.

- Welding phase = 60% of 10 minutes = 6 minutes
- Cooling phase = remaining time = 4 minutes
- After the cooling phase, the cycle begins anew.

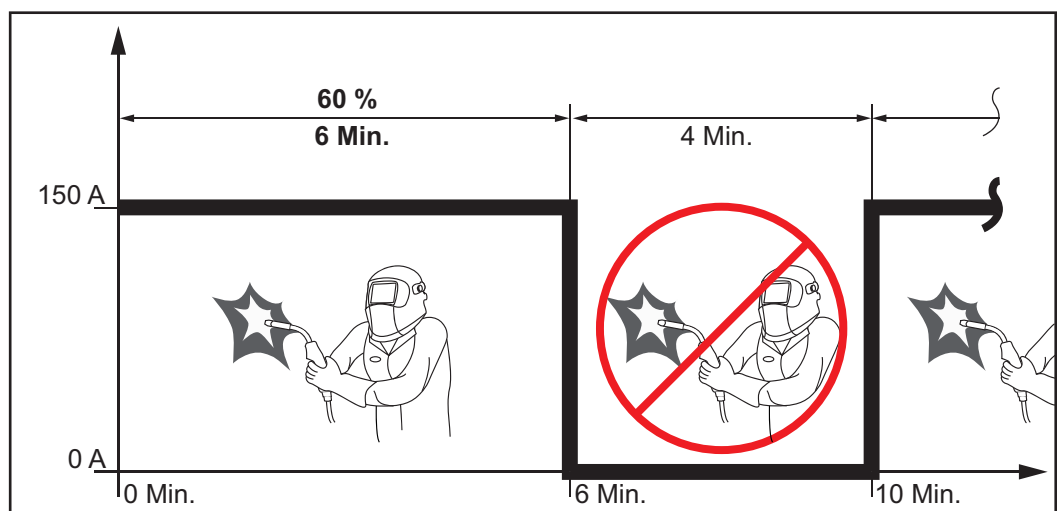

If the device is to be continuously operated without stopping:

- 1 look in the technical data for a D.C. value of 100% for the reigning ambient temperature.

- 2 Reduce the output or amperage in line with this value so that the device can remain in use without observing a cooling phase.

## Technical data

Battery nominal voltage		52.8 V
Charging current		10 A
Rapid charging current		18 A
Battery capacity		7,5 Ah
Battery type		Li-ion
Welding current range	Electrode DC	10 -140 A
	TIG DC	3 - 150 A
Welding current in hybrid mode, MMA welding		
	40 °C (104 °F)	18% D.C. <sup>1)</sup>
	40 °C (104 °F)	25% D.C. <sup>1)</sup>
	40 °C (104 °F)	100% D.C. <sup>1)</sup>
Welding current in hybrid mode, TIG welding		
	40 °C (104 °F)	25% D.C. <sup>1)</sup>
	40 °C (104 °F)	50% D.C. <sup>1)</sup>
	40 °C (104 °F)	100% D.C. <sup>1)</sup>
Open circuit voltage		91 V
Reduced open circuit voltage (only with VRD option)		14 V
Protection class		IP 23
Type of cooling		AF
Mark of conformity		CE, S
Dimensions (l x w x h)		435 x 160 x 310 mm
		17.1 x 6.3 x 12.2 in.
Weight		10.9 kg (24.3 lb.)

<sup>1)</sup> D.C. = Duty cycle

# Charger





# General

## Warning notices on the device

A number of safety symbols can be seen on the charger's rating plate. The safety symbols must not be removed or painted over.

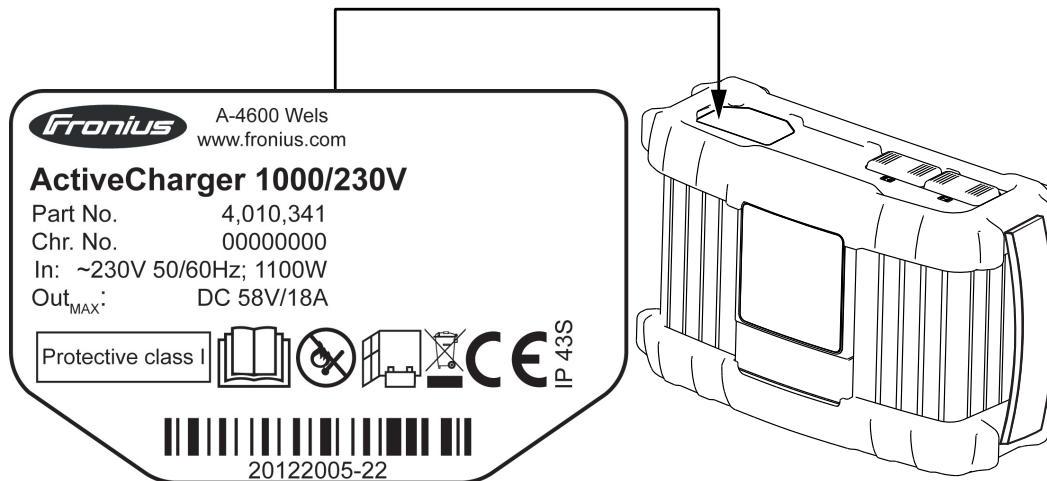

Do not use the functions described here until you have fully read and understood the following documents:

- these operating instructions
- all the operating instructions for the system components of the power source, especially the safety rules



Possible sources of ignition, such as fire, sparks and naked flames, must be kept away from the battery.



Ensure an adequate supply of fresh air during charging. Set up the device at least 50 cm (19.69 in.) off the floor.



Do not dispose of used devices with domestic waste. Dispose of them according to the safety rules.

## Warning notices inside the device



An electric shock can be fatal. Do not open the device!

The housing must never be opened by anyone other than a Fronius-trained service engineer. The device must be disconnected from the mains before starting any work with the housing open. A suitable measuring instrument must be used to ensure that electrically charged components (e.g. capacitors) are fully discharged. Ensure that the device remains disconnected from the mains until all work has been completed.

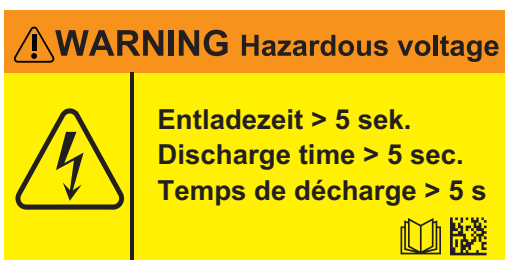

This warning sign is located inside the device. It must NOT be removed or painted over.

The discharge time of the capacitors is approx. one minute.

## Proper use

The charger is designed to charge the power sources listed below. Any use above and beyond this purpose is deemed improper. The manufacturer shall not be liable for any damage resulting from such improper use. Proper use also includes:

- carefully reading these operating instructions
- following all the instructions and safety rules in these operating instructions

### **WARNING!**

**Charging any other devices can cause serious injury or damage, and is therefore prohibited.**

The following power sources may be charged:

- Fronius AccuPocket 150/400
- Fronius AccuPocket 150/400 TIG



The charger is intended solely for commercial use.

# Before commissioning

---

**Mains connection** The rating plate, which is located on the housing, contains information about the permitted mains voltage. The device is designed for this mains voltage only. For details on the required fuse protection for the mains lead, see the **Technical data** section on page 74. If there is no mains cable or mains plug on your version of the appliance, fit one that conforms to national standards.

## NOTE!

**An inadequately dimensioned electrical installation can cause serious damage.**

The mains lead and its fuse must be dimensioned to suit the local power supply. The technical data shown on the rating plate applies.

---

**Generator-powered operation** The charger is completely generator-compatible, provided the maximum apparent power delivered by the generator is at least 2 kVA. This also applies if the generator in question is an inverter.

## NOTE!

**The voltage delivered by the generator must never exceed the upper or lower limits of the mains voltage tolerance range.**

---

Details on the mains voltage tolerance can be found in the **Technical data** section on page 74.

---

## Setup regulations



### WARNING!

**Toppling or falling devices can cause life-threatening injuries.**

Place devices on a solid, level surface so that they remain stable.

---

The device is tested to IP 43S protection, meaning:

- protection against penetration by solid foreign bodies with diameters > 1.0 mm (0.04 in.)
- protection against direct sprays of water at any angle up to 60° from the vertical, if the fan does not run.

### Dust

Ensure that metallic dust is not sucked into the system by the fan, when carrying out grinding for example.

### Outdoor operation

The device can be set up and operated outdoors in accordance with IP43S degree of protection. Avoid direct wetting (e.g. from rain).

**Space requirements**

**NOTE!**

**If the charger is installed in a switch cabinet (or a similar sealed area), then forced-air ventilation must be provided to ensure adequate heat dissipation.**

There should be an all-round clearance of 10 cm (3.9 in.) around the charger.

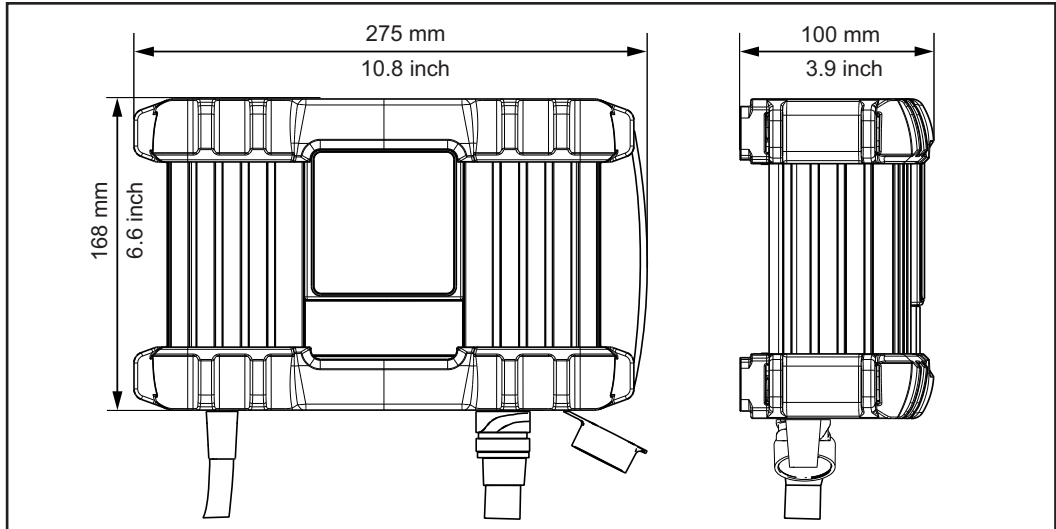

# Control elements and connections

## Safety

**WARNING!**

**Operating the equipment incorrectly can cause serious injury and damage.**  
 Do not use the functions described until you have thoroughly read and understood the following documents:

- ▶ these operating instructions
- ▶ all the operating instructions for the system components, especially the safety rules

**NOTE!**

**Due to software updates, you may find that your device has certain functions that are not described in these operating instructions or vice versa.**  
 Individual illustrations may also differ slightly from the actual controls on your device, but these controls function in exactly the same way.

## Connections and components

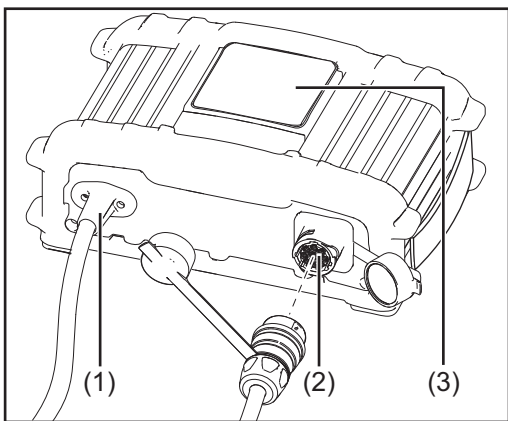

- (1) **Mains cable**  
for connection to the mains
- (2) **Connection P1 - charging lead socket**  
to plug in the charging cable for connection to the power source
- (3) **Control panel**

## Control panel

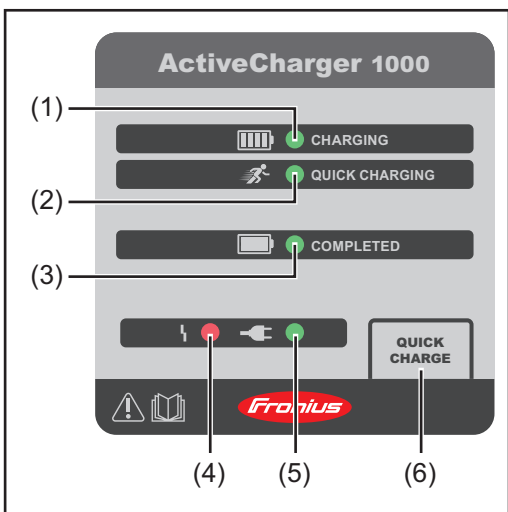

- (1) **CHARGING indicator (green)**  
Charging in progress
- (2) **QUICK CHARGING indicator (green)**  
Quick charging in progress
- (3) **COMPLETED indicator (green)**  
Power source fully charged
- (4) **Error indicator (red)**  
See the **Troubleshooting** section on page **73**
- (5) **Mains indicator (green)**  
Mains supply voltage available
- (6) **QUICK CHARGE button**  
Starts and stops quick charging

# Start-up

## Safety



### WARNING!

**Incorrect operation or shoddy workmanship can cause serious injury or damage.**

All activities described in these operating instructions may only be carried out by trained and qualified personnel. All functions described in these operating instructions may only be used by trained and qualified personnel. Do not carry out any of the work or use any of the functions described until you have fully read and understood the following documents:

- ▶ these operating instructions
- ▶ all the operating instructions for the system components, especially the safety rules

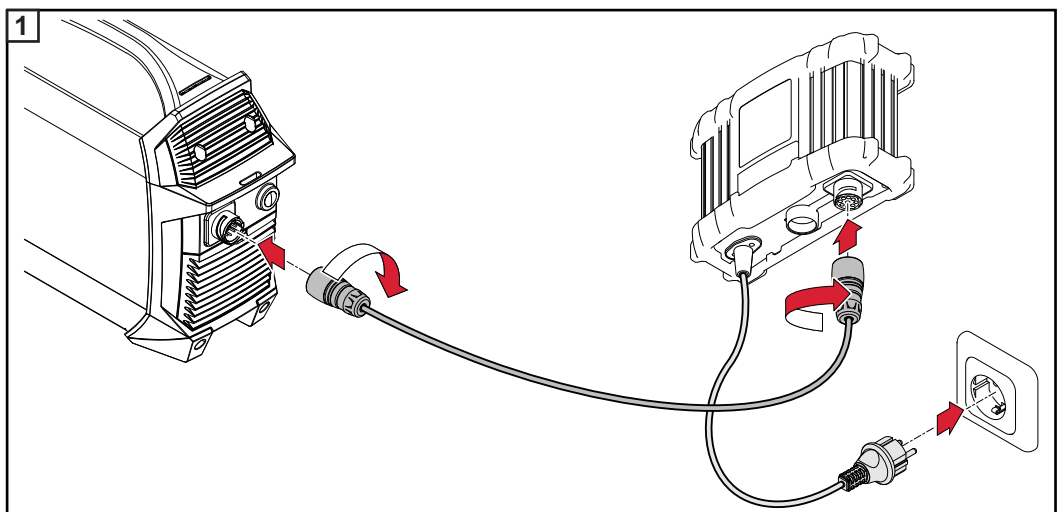

## Commissioning



-  Once connected, the battery capacity indicator on the power source flashes to indicate the current state of charge; the battery is being charged

- 2 Select Quick Charge mode if required - details on the available operating modes can be found in the following section

If the battery is fully charged:











-  The COMPLETED indicator lights up on the charger
-  On the power source, all segments of the battery capacity indicator are lit

### NOTE!

**The system includes the following features for maximum user-friendliness:**

- ▶ It does not matter in what order the devices are connected to the mains
- ▶ The power source can even be connected to the charger while it is in use

## Operating modes

Operating mode	Activation/deactivation	Features
Charging	Starts automatically when the charger is connected to the power source and the mains	<ul style="list-style-type: none"> <li>-  The CHARGING indicator is lit</li> <li>-  Mains indicator lit</li> <li>- The power source is charged at optimum charging power</li> <li>- The charging characteristic of this mode maximises the service life of the power source</li> <li>-  When the COMPLETED indicator lights up, the power source is fully charged and the charger switches to conservation charging mode</li> </ul>
Quick charging	Activation: <ol style="list-style-type: none"> <li>1 Press the QUICK CHARGING button</li> </ol> Deactivation: <ol style="list-style-type: none"> <li>1 Press the QUICK CHARGING erneut drücken button again               <ul style="list-style-type: none"> <li>- Charging mode resumes</li> </ul> </li> </ol>	<ul style="list-style-type: none"> <li>-  The QUICK CHARGING indicator is lit</li> <li>-  Mains indicator lit</li> <li>- The power source is charged at the maximum possible charging power</li> <li>-  When the COMPLETED indicator lights up, the power source is fully charged and the charger switches to conservation charging mode</li> </ul>
Conservation charging	Starts automatically once the charger has fully charged the power source	<ul style="list-style-type: none"> <li>-  Mains indicator lit</li> <li>-  The COMPLETED indicator is lit</li> <li>- The power source is charged at conservation charging power</li> <li>- In this mode, the power source can remain connected to the charger without being damaged</li> </ul>
Hybrid mode = the charger is charging the power source while the power source is in operation	Activation: <ol style="list-style-type: none"> <li>1 Start welding during charging</li> <li>1 or connect the power source to the charger while it is in operation</li> </ol>	<ul style="list-style-type: none"> <li>-  The QUICK CHARGING indicator is lit (charging at the maximum possible charging power in hybrid mode)</li> <li>-  Mains indicator lit</li> <li>- The power source is discharged according to its operating load and simultaneously recharged by the charger</li> </ul>

# Options

## Fitting the wall bracket

### NOTE!

Depending on the underlying surface, different wall plugs and screws are needed to fit the wall bracket.

Wall plugs and screws are therefore not included in the scope of supply. The installer is responsible for selecting the right wall plugs and screws.

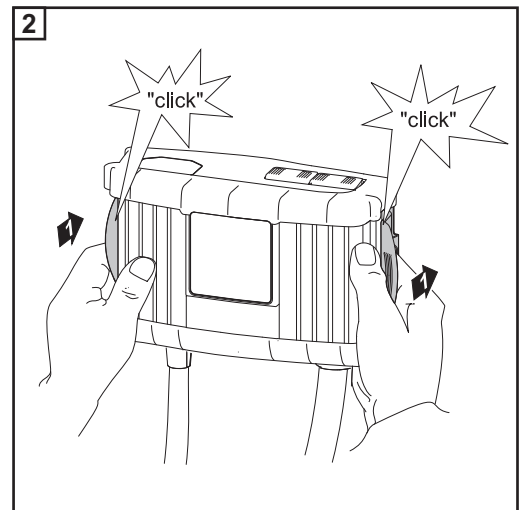
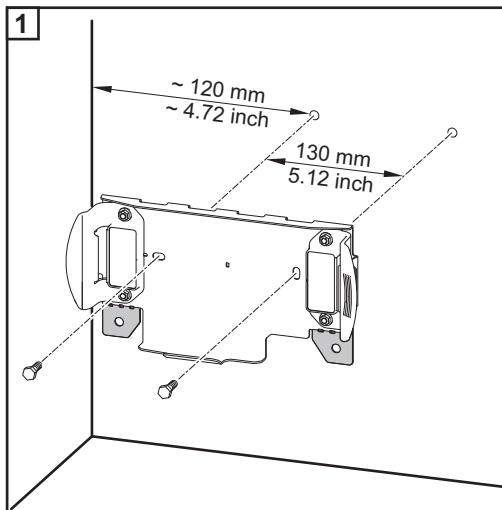



# Troubleshooting

## Safety



### WARNING!

**An electric shock can be fatal.**  
Do not open the device.

## Indicated errors

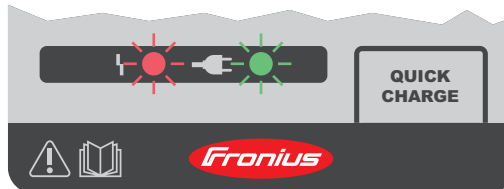

An error is signalled by the following indicators flashing or lighting up:

-  Error indicator
-  Mains indicator

### Error flashing, mains lit

Cause: Battery fault  
Remedy: Contact After-Sales Service

### Error flashing, mains flashing

Cause: Mains fault (overvoltage or undervoltage)  
Remedy: Check mains supply voltage (see Technical data)

### Error lit, mains lit

Cause: Charger fault  
Remedy: Contact After-Sales Service

## No function

### Mains fuse or automatic circuit breaker trips

Cause: Mains fuse underrated/incorrect circuit breaker  
Remedy: Fuse mains correctly (see Technical data)

Cause: Mains fuse trips in open circuit  
Remedy: Contact After-Sales Service

# Technical data

## Operating environments



Transport, storage or operation of the charger outside the stipulated area will be deemed improper. The manufacturer shall not be held liable for any damage arising from such usage.

Ambient temperature range:

- during operation: -10 °C to +40 °C (14 °F to 104 °F)
- during transport and storage: -20 °C to +55 °C (-4 °F to 131 °F)
- recommended temperature range during charging: + 4 °C to + 40 °C (+ 39,2 °F to + 104 °F)

Relative humidity:

- up to 50 % at 40 °C (104 °F)
- up to 90 % at 20 °C (68 °F)

The surrounding air must be free from dust, acids, corrosive gases or substances, etc.

Can be used at altitudes up to 2000 m (6561 ft.)

## Technical data 230V

Mains voltage	~ 230 V AC, ±15%
Mains frequency	50 / 60 Hz
Mains current	max. 9.5 A eff.
Mains fuse	max. 16 A
Efficiency	max. 95%
Effective power	max. 1100 W
Apparent power	max. 2370 VA
Power consumption (standby)	max. 2.1 W
Protection class	I (with PE conductor)
Maximum permitted mains impedance at the interface (PCC) to the public grid	none
EMC emission class	A
Mark of conformity	CE
Output voltage range	30 - 58 V DC
Output current	max. 18 A DC
Output power	max. 1040 W
Cooling	Convection and fan
Dimensions l x w x h	270 x 168 x 100 mm
Weight (without cable)	approx. 2 kg
Protection class	IP43S
Overvoltage category	II
Device may only be operated on neutral-earthed systems.	

**Standards 230V**

EN 62477-1	
EN 60974-10	(Class A)

**Technical data  
120V**

Mains voltage	~ 120 V AC, $\pm 15\%$
Mains frequency	50/60 Hz
Mains current	max. 15 A eff.
Mains fuse	max. 20 A
Efficiency	max. 94 %
Effective power	max. 1100 W
Apparent power	max. 1900 VA
Power consumption (standby)	max. 1.6 W
Protection class	I (with ground conductor)
Maximum permitted mains impedance at the interface (PCC) to the public grid	none
EMC device class	A
Mark of conformity	cTÜVus
Output voltage range	30 - 58 V DC
Output current	max. 18 A DC
Output power	max. 1000 W
Cooling	Convection and fan
Dimensions l x w x h	270 x 168 x 100 mm
Weight	approx. 2 kg
Degree of protection	IP43S
Overvoltage category	II
Device may only be operated on neutral-earthed systems.	

**Standards 120V**

UL 1012	
C22.2 No.107.1-01	
FCC CFR 47 Part 15	(Class A)

**Technical data  
100V**

Mains voltage	~ 100 - 110 V AC, +10% / -15%
Mains frequency	50/60 Hz
Mains current	max. 15.7 A eff.
Mains fuse	max. 16 A
Efficiency	max. 92 %
Effective power	max. 940 W

Apparent power	max. 1600 VA
Power consumption (standby)	max. 1.6 W
Protection class	I (with ground conductor)
Maximum permitted mains impedance at the interface (PCC) to the public grid	none
EMC device class	A
Mark of conformity	CE
Output voltage range	30 - 58 V DC
Output current	max. 18 A DC
Output power	max. 840 W
Cooling	Convection and fan
Dimensions l x w x h	270 x 168 x 100 mm
Weight	approx. 2 kg
Degree of protection	IP43S
Overvoltage category	II
Device may only be operated on neutral-earthed systems.	

---

**Standards 100V**

EN 62477-1	
EN 60974-10	(Class A)

# Appendix

# Spare parts list: AccuPocket

**AccuPocket 150** 4,075,200  
**AccuPocket 150 TIG** 4,075,201

	M4x12	42,0401,1185
	M4x20	42,0401,1211
	M5x10	42,0401,1024
	M5x18	42,0401,4229

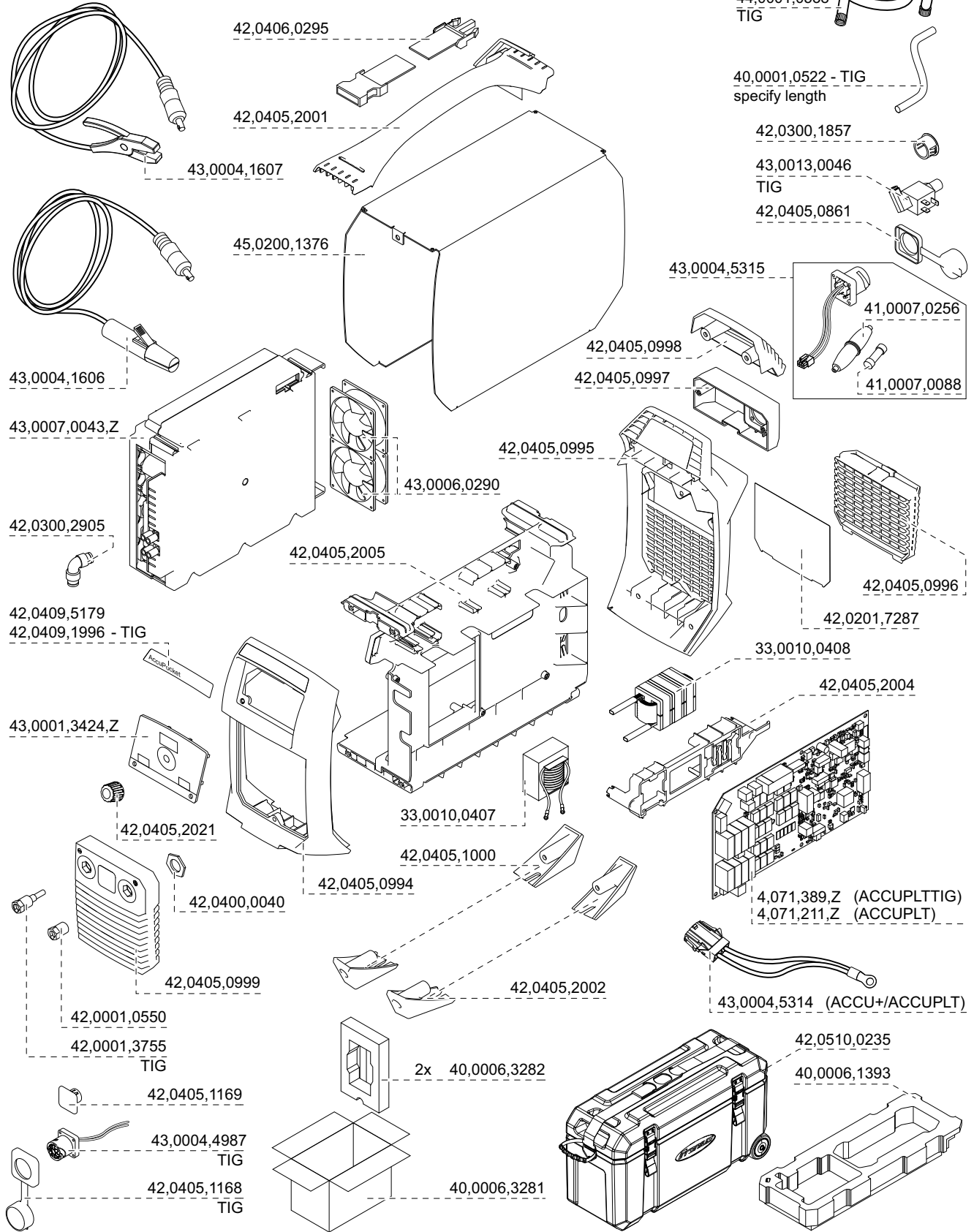

# Spare parts list: ActiveCharger

- 4,010,341 Active Charger 1000/230V/E
- 4,010,341,850 Active Charger 1000/230V/np/E
- 4,010,341,862 Active Charger 1000/230V/J
- 4,010,341,852 Active Charger 1000/230V/np/J
- 4,010,341,863 Active Charger 1000/230V/G
- 4,010,341,853 Active Charger 1000/230V/np/G
- 4,010,341,865 Active Charger 1000/230V/nc
- 4,010,341,855 Active Charger 1000/230V/np/nc
  
- 4,010,342 Active Charger 1000/120V/B
- 4,010,342,850 Active Charger 1000/120V/np/B
- 4,010,342,864 Active Charger 1000/100V/nc
- 4,010,342,854 Active Charger 1000/100V/np/B
- 4,010,342,866 Active Charger 1000/120V/nc
- 4,010,342,856 Active Charger 1000/120V/np/nc
- 4,010,342,865 Active Charger 1000/100V/np/B

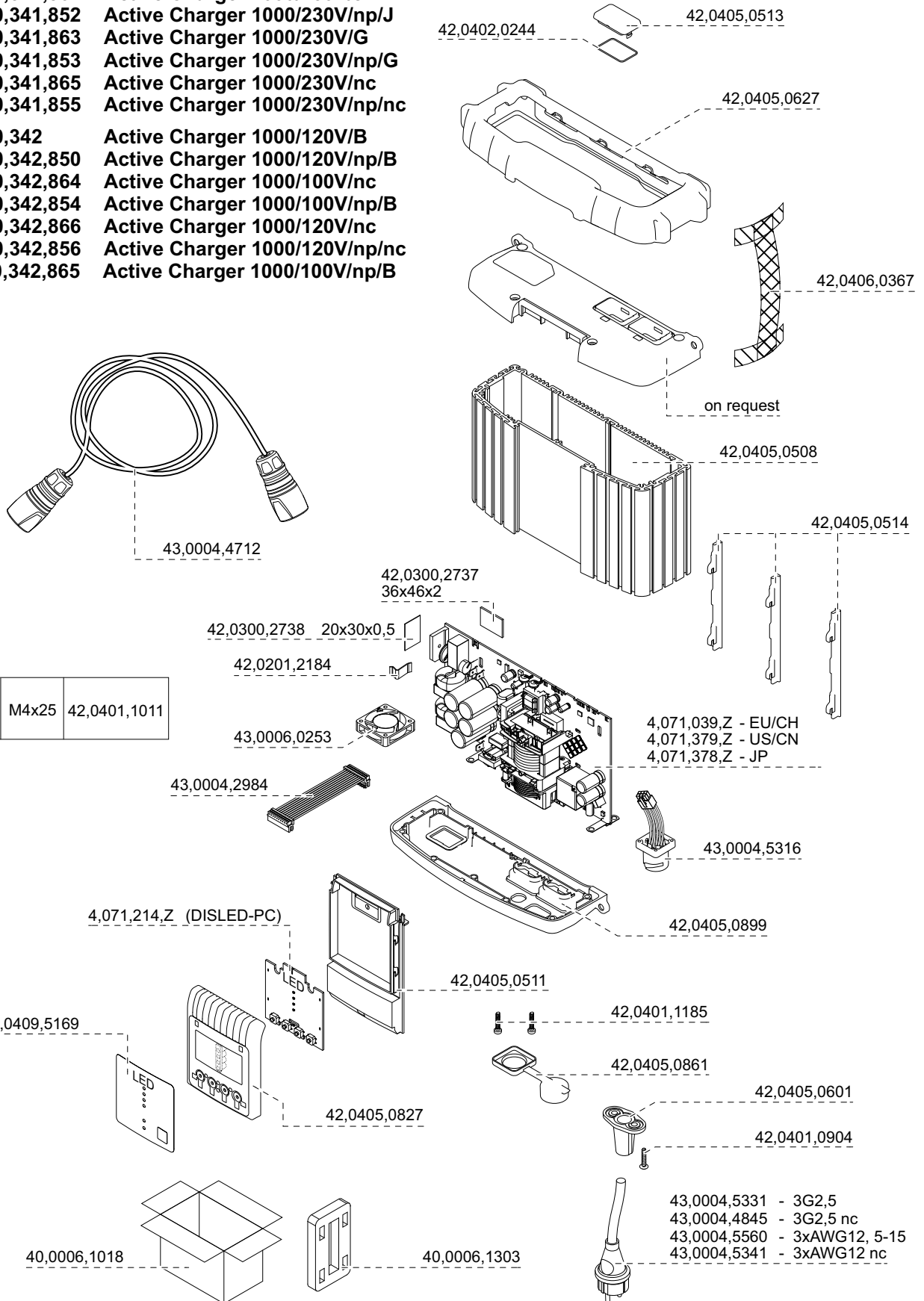



**FRONIUS INTERNATIONAL GMBH**

Froniusplatz 1, A-4600 Wels, Austria

Tel: +43 (0)7242 241-0, Fax: +43 (0)7242 241-3940

E-Mail: [sales@fronius.com](mailto:sales@fronius.com)

[www.fronius.com](http://www.fronius.com)

**[www.fronius.com/addresses](http://www.fronius.com/addresses)**

Under <http://www.fronius.com/addresses> you will find all addresses  
of our Sales & service partners and Locations