

# AUTUMN FLYER 2020

Be Smart. Be Safe. Be Sure.



STRONGARM



## 2 in 1 Die Grinder Combo

**NEW**

**WHILE QUANTITIES LAST**



- Contains 1 each: 90° mini die grinder (402009) and 1 straight mini die grinder (402010)
- Ball bearing construction for maximum tool life and durability
- Lever throttle for positive speed control
- Built in regulator
- Front exhaust

402148 MDGPROMO | List \$131.60

**SALE**

**\$94.95**

## 8 Piece Screwdriver Set with Bonus Opener

**NEW**

**Bonus!**



- Cushion grip Screwdrivers includes: 3/16" x 3" - Cabinet, 1/4" x 4" - Slotted, 5/16" x 6" - Slotted, #2 x 4" - Phillips, #2 x 1-1/2" - Stubby Phillips, 1/4" x 1-1/2" - Stubby Slotted, #2 x 1-1/2" - Stubby Square, #2 x 4" - Square

720563 JKS-8SB | List \$103.40

**SALE**

**\$59.95**

## 5,500 lb Capacity Heavy Duty Pallet Truck

**SUPER SPECIAL**

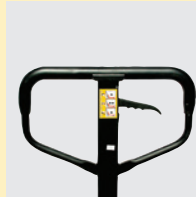

- High quality 5,500 lb capacity
- High tensile steel frame and one piece "C" section forks with welded reinforcement for superior strength
- 3 position control lever automatically returns to neutral position
- Handle operates from rear and sides and returns to upright position when released
- Ergonomic handle grip for operator comfort and positive control
- Entry rollers in front of load rollers allow easy entry and exit from pallets
- Totally sealed hydraulic pump for reliable leak-free operation
- Built-in overload protection and top of stroke bypass valve prevents damage

190918 PT-5500 | List \$801.55

**SALE**

**\$539.95**

Featuring  
**JET**  
Professional  
Tool Storage  
See page 22



**TOOLS & EQUIPMENT**

Sale pricing in effect until December 31, 2020

# JOBSITE

1-888-634-3030 | [JobsiteEquipment.ca](http://JobsiteEquipment.ca)

## 42 PC 1/4" DR SAE/Metric Socket Wrench Sets



- 3/16 – 1/2"
- 4 – 12 mm
- Standard and deep length
- CrV Steel

PROD. NO.	MOD. NO.	# of Points	List	Sale
600125	SW1442C-6	6	\$172.40	<b>\$99.95</b>
600126	SW1442C-12	12	\$172.40	<b>\$99.95</b>

## 55 PC 1/2" DR SAE/Metric Socket Wrench Sets



- 3/8 – 1-1/4", 10 – 32 mm Standard Length
- 7/16 – 7/8", 10 – 21 mm Deep Length
- CrV Steel

PROD. NO.	MOD. NO.	# of Points	List	Sale
600341	SW1255C-6	6	\$517.30	<b>\$299.95</b>
600342	SW1255C-12	12	\$517.30	<b>\$299.95</b>

## 45 PC 3/8" DR SAE/Metric Socket Wrench Sets



- 3/8 – 3/4"
- 8 – 19 mm Standard Length
- 3/8 – 13/16"
- 8 – 19 mm Deep Length
- CrV Steel

PROD. NO.	MOD. NO.	# of Points	List	Sale
600241	SW3845C-6	6	\$336.20	<b>\$194.95</b>
600242	SW3845C-12	12	\$336.20	<b>\$194.95</b>

## 24 PC 1/4" DR SAE Socket Wrench Set - 6 Point



- 3/16 – 1/2" Standard and Deep Length
- CrV Steel

600115 SW1424-6 | List \$127.55

**SALE**

**\$73.95**

## 21 PC 3/8" DR SAE Socket Wrench Set - 6 Point



- 3/8 – 3/4" Standard Length
- 3/8 – 13/16" Deep Length
- CrV Steel

600229 SW3821-6 | List \$189.60

**SALE**

**\$109.95**

## 30 PC 3/8" DR Metric Socket Wrench Set - 6 Point



- 8 – 19 mm Standard and Deep Length
- CrV Steel

600234 SW3830M-6 | List \$218.95

**SALE**

**\$126.95**

**20 PC 1/2" DR  
SAE Socket  
Wrench Set  
- 6 Point**



- 7/16 – 1-1/4"
- Standard length
- CrV Steel

**600323** SW1220-6 | List \$310.35

**SALE \$179.95**

**24 PC 1/2" DR  
Metric Socket Set  
- 6 Point**



- 12 – 24 mm
- Standard length
- CrV Steel

**600329** SW1224M-6 | List \$327.60

**SALE \$189.95**

**29 PC 1/2" DR  
SAE Socket  
Wrench Set  
- 6 Point**



- 3/8 – 1-1/4" Standard Length
- 7/16 – 7/8" Deep Length
- CrV Steel

**600331** SW1229-6 | List \$344.85

**SALE \$199.95**

**21 PC 3/4" DR  
SAE Socket  
Wrench Set  
- 12 Point**



- 3/4 – 2"
- CrV Steel

**600406** SW7521-HD | List \$706.45

**SALE \$389.95**

**21 PC 1" DR SAE Socket Wrench Set - 12 Point**



- 1-7/16 – 3-1/8"
- CrV Steel

**600503** SW1021 | List \$2,083.25

**SALE \$1,099.95**

**21 PC 3/4" DR SAE Socket Wrench Set - 12 Point**



- 3/4 – 2"
- CrV Steel

**600402** SW7521 | List \$597.75

**SALE \$329.95**

### 7 PC 3/8" DR SAE Universal Socket Set - 6 Point



- Hardened steel universal joint allows access to confined areas
- 3/8 – 3/4"

601241 UJS-3807 | List \$120.65

**SALE \$69.95**

### 10 PC 3/8" DR Metric Universal Socket Set - 6 Point



- Hardened steel universal joint allows access to confined areas
- 10 – 19 mm

601242 UJS-3810M | List \$155.15

**SALE \$89.95**

### 7 PC 3/8" DR SAE Universal Impact Socket Set - 6 Point



- 1/2 – 7/8"
- CrMo Steel

610282 PSU738 | List \$120.65

**SALE \$69.95**

### 28 PC 1/4", 3/8" and 1/2" DR External TORX® Socket Set



- E4 – E24
- Blow mould case

601811 SS328TS | List \$177.55

**SALE \$99.95**

### 11 PC 1/4" & 3/8" DR Non-Tamperproof TORX® Bit Socket Set



- 3/8" DR 2" (Overall Length) TORX Bit
- Standard length external TORX
- 2" (Overall Length) TORX Bit
- 1/4" DR 1-1/2" (Overall Length) TORX Bit

601806 SS1438-11T | List \$72.35

**SALE \$39.95**

### 7 PC 3/8" DR SAE Universal Deep Impact Socket Set - 6 Point



- 1/2 – 7/8"
- CrMo Steel

610283 PSU738D | List \$172.40

**SALE \$99.95**

### 7 PC 3/8" DR 2" Long Hex Bit Socket Sets



- 2" Overall Length
- 601201: 1/8 – 3/8"
- 601202: 3 – 10 mm
- Includes rail
- S2 steel

PROD. NO.	MOD. NO.	Standard	List	Sale
601201	HSW3811	SAE	\$51.65	\$29.95
601202	HSW3811M	Metric	\$51.65	\$29.95

### 7 PC 3/8" DR 4" Long Ball Nose Socket Sets



- 601804: 1/8 – 3/8"
- 601805: 4 – 10 mm
- Includes socket rail
- S2 steel

PROD. NO.	MOD. NO.	Standard	List	Sale
601804	LHSW-3807	SAE	\$89.60	\$49.95
601805	LHSW-3807M	Metric	\$89.60	\$49.95

### 10 PC 3/8" DR Metric Universal Impact socket Set - 6 Point



- 10 – 19 mm
- CrMo Steel

610288 PSU1038M | List \$172.40

**SALE \$99.95**

### 8 PC 1/2" DR Hex Bit Impact Socket Sets



- 610331: 1/4 – 3/4"
- 610333: 6 – 19 mm

PROD. NO.	MOD. NO.	Standard	List	Sale
610331	PHB-1208	SAE	\$155.15	\$89.95
610333	PHB-1208M	Metric	\$155.15	\$89.95

### 5 PC 3/4" DR Impact Hex Bit Socket Sets



- 610411: 3" Length: 5/8 – 1-1/4"
- 610421: 3" Length: 17 – 23 mm

PROD. NO.	MOD. NO.	Standard	List	Sale
610411	PHB-3405	SAE	\$250.00	\$144.95
610421	PHB-3405M	Metric	\$250.00	\$144.95

### 10 PC 3/8" DR Metric Universal Deep Impact socket Set - 6 Point



- 10 – 19 mm
- CrMo Steel

610289 PSU1038DM | List \$241.40

**SALE \$139.95**

## 22 PC SAE/Metric Ball Nose Hex Key Set



- 0.05 – 3/8"
- 1.5 – 10 mm
- CrV Steel

775164 JBHK-22SM | List \$56.85

**SALE \$32.95**

## 10 PC Ball Nose Hex Key Sets



- 775173: 1/16 – 3/8"
- 775184: 1.5 – 10 mm
- CrV Steel

PROD. NO.	MOD. NO.	Standard	List	Sale
775173	JBHK-10	SAE	\$32.70	\$18.95
775184	JBHK-9M	Metric	\$30.95	\$17.95

## 9 PC Extra Long Ball Nose Hex Key Sets



- 775175: 1/16 – 3/8"
- 775185: 1.5 – 10 mm
- S2 Steel

PROD. NO.	MOD. NO.	Standard	List	Sale
775175	JBHK-9XL	SAE	\$51.65	\$29.95
775185	JBHK-9XLM	Metric	\$51.65	\$29.95

## 9 PC SAE Ergonomic L-Handle Ball Nose Hex Key Set



- 775104: 5/64 – 3/8"
- 775106: 2.0 – 10 mm
- S2 Steel
- Blow mould case

PROD. NO.	MOD. NO.	Standard	List	Sale
775104	JTHK-9	SAE	\$158.60	\$91.95
775106	JTHK-9M	Metric	\$158.60	\$91.95

## 25 PC Hex Key Set



- 1/16 – 3/8"
- 1.5 – 10 mm
- CrV Steel
- Blow mould case

775165 JHK-25SM | List \$41.30

**SALE \$23.95**

## 24 PC Folding Hex & Torx® Key Bonus Pack



- SAE: 5/64 – 1/4"
- Metric: 1.5 – 6 mm
- Torx: T8 – T40

775160 JFHK-24S | List \$34.40

**SALE \$19.95**

## 4 PC Mechanic's Pry Bar Set



- 8, 12, 18, 24"

779220 JMPB-4S | List \$117.20

**SALE \$67.95**

## 4 PC Jumbo Handle Mechanic's Pry Bar Set

**SUPER SPECIAL**



- 24 and 36" bars
- Blow mould case

779240 JHPB-4S | List \$512.15

**SALE \$199.95**

## 4 PC Rolling Head Pry Bar Set



- Heat treated Chrome Vanadium steel for professional use
- Magnetic particle tested to ensure complete material integrity
- Includes: 6, 12, 16, 20"

859211 JRPB-4S | List \$187.90

**SALE \$108.95**

## 7 PC T Handle Torx Key Set



- PVC grip provides comfort

775103 JTTK-7T | List \$93.05

**SALE \$53.95**

## 13 PC SAE Short Arm Hex Key Set



- 0.05 – 3/8"
- CrV Steel

775112 JHK-13 | List \$22.35

**SALE \$12.95**

## 9 PC Metric Short Arm Hex Key Set



- 1.5 – 10 mm
- CrV Steel

775114 JHK-9M | List \$20.60

**SALE \$11.95**

**26 PC 1/2" DR SAE Impact Socket Set**



**NEW**

- The most popular 1/2" drive sizes in Regular and Deep Lengths!
- TORQUE DRIVE® socket design contacts the fastener on the sides instead of the corners, reducing fastener rounding and allowing up to 20% more torque
- Standard Sockets: 7/16, 1/2, 9/16, 5/8, 11/16, 3/4, 13/16, 7/8, 15/16, 1", 1-1/16, 1-1/8, 1-1/4"
- Deep Sockets: 7/16, 1/2, 9/16, 5/8, 11/16, 3/4, 13/16, 7/8, 15/16, 1", 1-1/16, 1-1/8, 1-1/4"

**610330 PS2612SD** | List \$293.10

**SALE \$169.95**

**19 PC 1/2" DR Deep SAE Impact Socket Set - 6 Point**



- 3/8 – 1-1/2"
- CrMo Steel

**610329 PS1912D** | List \$339.65

**SALE \$196.95**

**27 PC 1/2" DR Deep SAE/Metric Impact Socket Set - 6 Point**



- 7/16 – 1-1/4"
- 10 – 24 mm
- 5" extension and universal joint
- CrMo Steel

**610327 PS2712DC** | List \$482.80

**SALE \$279.95**

**13 PC 1/2" DR Deep SAE Impact Socket Set - 6 Point**



- 7/16 – 1-1/4"
- GRM Steel

**610323 PS1312D** | List \$206.85

**SALE \$119.95**

**22 PC 1/2" DR Deep Metric Impact Socket Set - 6 Point**



- 10 – 32 mm
- CrMo Steel

**610339 PSS2212DM** | List \$379.35

**SALE \$219.95**

**14 PC 3/4" DR Deep SAE Impact Socket Set - 6 Point**



- 3/4 – 1-5/8"
- CrMo Steel

**610406 PS1434D** | List \$636.30

**SALE \$368.95**

**16 PC 3/4" DR  
SAE Impact  
Socket Set  
- 6 Point**



- 3/4 – 2"
- CrMo Steel

**610403** PS1634 | List \$569.05

**SALE \$329.95**

**21 PC 3/4" DR  
SAE Impact  
Socket Set  
- 6 Point**



- 3/4 – 2"
- CrMo Steel

**610409** PS2134 | List \$741.50

**SALE \$429.95**

**21 PC 3/4" DR  
Deep SAE Impact  
Socket Set  
- 6 Point**



- 3/4 – 2"
- CrMo Steel

**610410** PS2134D | List \$1,155.40

**SALE \$669.95**

**18 PC 1" DR  
SAE Impact  
Socket Set  
- 6 Point**



- 3/4 – 2"
- CrMo Steel

**610509** PS1801 | List \$741.50

**SALE \$429.95**

**12 PC 1" DR  
SAE Impact  
Socket Set  
- 6 Point**



- 2-1/8 – 3-1/2"
- CrMo Steel

**610506** PS1201 | List \$1,802.25

**SALE \$999.95**

**16 PC 1" DR  
Deep SAE Impact  
Socket Set  
- 6 Point**



- 7/8 – 2"
- CrMo Steel

**610508** PS1601D | List \$1,241.65

**SALE \$699.95**

## JET is pleased to introduce our completely redesigned series of Locking Pliers and Locking Clamps.

The first thing you will notice is the bright blue Reverse Action release lever. Featuring more metal to metal contact and a reverse "pull up" action, these pliers are much easier to release while under heavy loads.

This is important, as the larger pliers and clamps also feature our unique 1/4" square drive hole in the adjustment screw for those times when you need to clamp work down really hard.

Backed up by the same industry-leading 9254 Steel jaw components and Chrome Molybdenum steel bodies and rivets you've come to expect from JET, and as always, you are covered by our famous Lifetime Warranty!



### QUICK RELEASE LEVER

- Reverse Action release lever is easier to operate under pressure
- Use finger to pull up on lever, rather than trying to push it down with the back of finger (painful!)

## 5 PC Locking Pliers Set - Super Heavy Duty



**NEW**

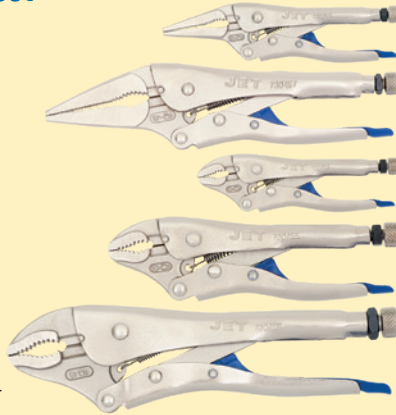

- Curved jaw: 5, 7, 10"
- Long nose: 6, 9"
- Reverse Action release lever

**730335 LPS-5** | List \$160.30

**SALE \$92.95**

## Curved Jaw Locking Pliers with Cutter



**NEW**

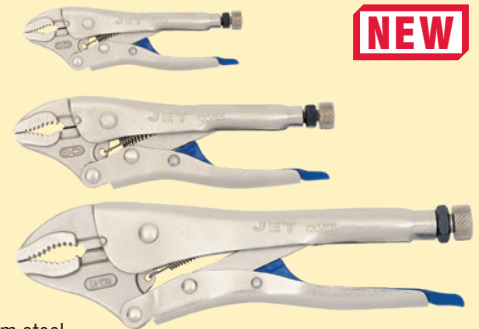

- Chrome Molybdenum steel
- Reverse Action release lever

PROD. NO.	MOD. NO.	Type	Length	List	Sale
730453	J5WR	Curved Jaw	5"	\$25.80	<b>\$14.95</b>
730455	J7WR	Curved Jaw	7"	\$29.25	<b>\$16.95</b>
730458	J10WR	Curved Jaw	10"	\$30.95	<b>\$17.95</b>

## Long Nose Locking Pliers with Cutter



**NEW**

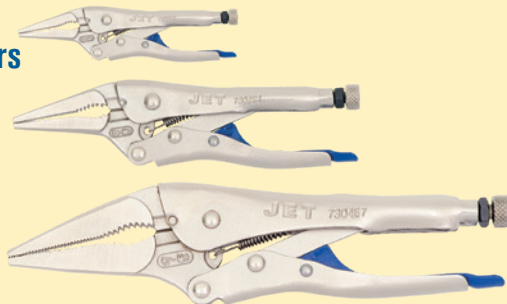

- Chrome Molybdenum steel
- Reverse Action release lever

PROD. NO.	MOD. NO.	Type	Length	List	Sale
730462	J4LN	Long Nose Pliers	4"	\$25.80	<b>\$14.95</b>
730463	J6LN	Long Nose Pliers	6"	\$30.95	<b>\$17.95</b>
730467	J9LN	Long Nose Pliers	9"	\$34.40	<b>\$19.95</b>

## 9" Locking Chain Wrench



**NEW**



- 20" chain
- Reverse Action release lever

**730496 J2OR** | List \$53.40

**SALE \$30.95**





**CONVENIENT FEATURES**

- Exclusive 1/4" square drive hole allows use of ratchet or flex bar to increase clamping pressure
- Lock Nut holds setting



**STEEL JAW**

- Exclusive 9254 steel jaw hardness increases below the surface, allowing for increased clamping pressure and offering longer tooth life

**8" Locking Sheet Metal Clamp**

**NEW**



- Made of industrial quality Chrome Molybdenum steel
- Reverse Action release lever

**730558 J8R** | List \$44.75

**SALE**

**\$25.95**

**Locking C-Clamps**

**NEW**



- Made of industrial quality Chrome Molybdenum steel
- Reverse Action release lever

PROD. NO.	MOD. NO.	Type	Length	List	Sale
730554	J6R	C-Clamp	6"	\$30.95	<b>\$17.95</b>
730556	J11R	C-Clamp	11"	\$48.20	<b>\$27.95</b>

**9" Locking Welder's Clamp**

**NEW**



- Made of industrial quality Chrome Molybdenum steel
- Reverse Action release lever

**730559 J9R** | List \$51.65

**SALE**

**\$29.95**

**Locking C-Clamps with Swivel Pads**

**NEW**



- Made of industrial quality Chrome Molybdenum steel
- Reverse Action release lever

PROD. NO.	MOD. NO.	Type	Length	List	Sale
730555	J6RP	C-Clamp with Pads	6"	\$34.40	<b>\$19.95</b>
730557	J11RP	C-Clamp with Pads	11"	\$51.65	<b>\$29.95</b>

### 4 PC 7" Snap Ring Pliers Set

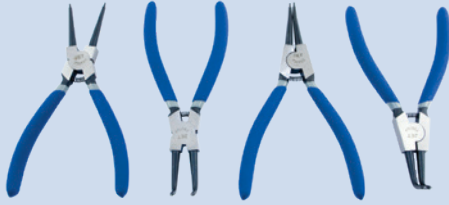

- Internal Straight, External Straight, Internal Bent, External Bent
- 730353 SRP-4S** | List \$70.60

**SALE \$40.95**

### 5 PC Mechanic's Pliers Set



- Cutting blades and teeth induction hardened to HRC 58-62
- Double dipped cushion grip handles provide sure grip and all day comfort

**730341 JPS-5M** | List \$124.10

**SALE \$71.95**

### 5 PC Industrial Pliers Set - Super Heavy Duty



- For heavy duty industrial applications
- 730306 JIPS-5SHD** | List \$151.70



**SALE \$79.95**

### 7" Snap Ring Plier Set - Super Heavy Duty

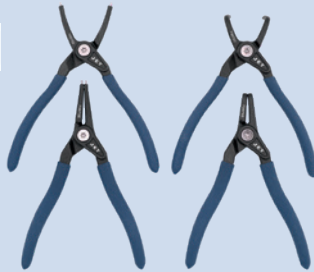

- Internal Straight, Internal Bent, External Straight, External Bent
- 730354 SRP-770S** | List \$189.60

**SALE \$109.95**

### 5 PC Pliers/Cutter Maintenance Set



- CrV steel
- 730321 JPS-5** | List \$112.00

**SALE \$64.95**

### Groove Joint Pliers



- Made of high quality Chrome Vanadium steel
- Cutting edges induction hardened to HRC58-62

PRODD. NO.	MOD. NO.	Capacity	List	Sale
730441	CLP-1	1-1/4"	\$24.65	<b>\$13.95</b>
730442	CLP-2	1-3/4"	\$32.90	<b>\$18.95</b>
730443	CLP-3	2-1/4"	\$35.25	<b>\$19.95</b>
730445	CLP-4	4"	\$81.25	<b>\$46.95</b>

### 10" Electrician's Cutting / Crimping Pliers - Heavy Duty



- 10" long
  - Heavy Duty
- 730473 WP-250** | List \$61.80

**SALE \$35.95**

### 10 PC VDE Tool Kit



- Individually tested and VDE certified for use on live circuits up to 1000 V
- Contains most commonly used VDE screwdrivers and pliers

**760002 JITK-10S** | List \$325.35

**SALE \$149.95**

### 10-1/2" Pliers Set - Ratcheting - Heavy Duty



- Heavy duty pliers for use on large, high tension retaining rings
- Spring loaded ratcheting mechanism reduces operator fatigue and enhances safety
- Rings can be compressed or expanded in stages and locked in place
- Heat treated high carbon steel pliers with Chrome Molybdenum tips
- Complete with 0°, 15°, 45°, and 90° tips in .108" and .120" sizes
- Capacity: External 1-1/2" - 3-3/4", Internal 2-7/16" - 4"
- Includes one external and one internal pliers, 16 Chrome Molybdenum tips, and 6 spare screws
- Replacement tips available

**730355 SRP-10S** | List \$224.10

**SALE \$129.95**

### 8-1/4" Wire Stripper / Cutter / Crimper



- 8 - 26 AWG
- 730724 JMWS-81024** | List \$42.35

**SALE \$24.95**

### 3 PC Aviation Snip Set - Super Heavy Duty



- Induction hardened for professional use
- Non-slip TPR grips

**735305 JAS-3S** | List \$89.60

**SALE \$49.95**

## 16 PC SAE Raised Panel Combination Wrench Set



- 1/4 – 1-1/4"
- CrV Steel
- Terylene pouch

700121 CWS-16S | List \$236.20

**SALE \$136.95**

## 16 PC SAE Long Pattern Wrench Set

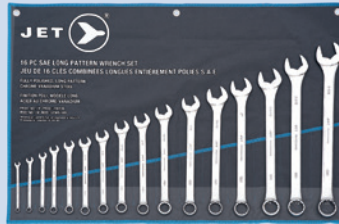

- 1/4 – 1-1/4"
- CrV Steel
- Terylene Pouch

700135 LCWS-16S | List \$379.35

**SALE \$219.95**

## 13 PC Long SAE Ratcheting Combination Wrench Set



- 1/4 – 1"
- CrV Steel
- Plastic rack

700312 RCWS-13S | List \$379.35

**SALE \$219.95**

## 16 PC Metric Raised Panel Combination Wrench Set



- 7 – 24 mm
- CrV Steel
- Terylene pouch

700173 CWS-16M | List \$175.85

**SALE \$99.95**

## Ratcheting Double Box Wrench Sets



- 700346: 5/16" x 3/8", 7/16" x 1/2", 9/16" x 5/8", 11/16" x 3/4"
- 700396: 8 x 9, 10 x 11, 12 x 13, 14 x 15, 16 x 18, 17 x 19 mm
- CrV Steel
- Terylene pouch

PROD. NO.	MOD. NO.	Standard	List	Sale
700346	RDBS-4S	SAE	\$137.90	\$79.95
700396	RDBS-6M	Metric	\$224.10	\$129.95

## 18 PC Metric Ratcheting Wrench Set



- 7 – 24 mm
- CrV Steel
- Terylene Pouch

700362 RCWS-18M | List \$638.00

**SALE \$369.95**

## 22 PC Metric Raised Panel Combination Wrench Set



- 7 – 32 mm
- CrV Steel
- Terylene pouch

700177 CWS-22M | List \$275.85

**SALE \$159.95**

## 7 PC SAE Flare Nut Crowfoot Set - 6 Point



- 6 point style distributes force over a greater area, protecting softer brass and aluminum fittings and providing greater user protection against slippage
- Open slot allows wrench to slip over hoses and lines to reach fasteners
- Chrome vanadium steel for professional use
- Excellent for use on hydraulic, brake, air conditioning, and fuel lines
- Drive with any 3/8" ratchet, extension, or other drive tool
- Includes socket rail for organization
- Sizes: 3/8, 7/16, 1/2, 9/16, 5/8, 11/16, 3/4"

719112 CFW3807-6 | List \$86.15

**SALE \$49.95**

## 10 PC SAE Jumbo Raised Panel Combination Wrench Set



- 1-5/16 – 2"
- S45C Alloy Steel

700128 JCW-10-2 | List \$862.25

**SALE \$499.95**

## 6 PC Metric Flare Nut Wrench Set



- 9 x 11, 10 x 12, 13 x 14, 15 x 17, 16 x 18, 19 x 21 mm
- CrV Steel
- Terylene pouch

719010 FN-6M | List \$103.40

**SALE \$59.95**

## 10 PC Metric Flare Nut Crowfoot Wrench Set - 6 Point



- 6 point style distributes force over a greater area, protecting softer brass and aluminum fittings and providing greater user protection against slippage
- Open slot allows wrench to slip over hoses and lines to reach fasteners
- Chrome vanadium steel for professional use
- Excellent for use on hydraulic, brake, air conditioning, and fuel lines
- Drive with any 3/8" ratchet, extension, or other drive tool
- Includes socket rail for organization
- Sizes: 10, 11, 12, 13, 14, 15, 16, 17, 18, 19 mm

719122 CFW3810-6M | List \$112.00

**SALE \$64.95**

## 4 PC SAE Flare Nut Wrench Set



- 1/4" x 5/16", 3/8" x 7/16", 1/2" x 9/16", 3/4" x 7/8"
- CrV Steel
- Terylene pouch

719005 FN-4S | List \$70.60

**SALE \$40.95**

## 3 PC Adjustable Wrench Set

**SUPER SPECIAL**



• Contains: 8, 10, and 12" wrenches  
**711102 AW-3S** | List \$68.90

**SALE \$29.95**

## Industrial Black Phosphate Adjustable Wrenches - Super Heavy Duty



- Chrome Vanadium steel wrenches with black phosphate finish for use in applications where plated products are prohibited
- No chrome plate to peel or chip, causing contamination in sensitive applications
- Finish is non-reflective for military applications
- Black phosphate provides superior corrosion resistance versus black oxide finishes
- Smaller 15° jaw angle provides greater leverage than standard 22° wrenches, reducing hand and arm fatigue
- Extra wide jaw openings fit an increased range of fasteners, offering greater versatility and value
- Thin tapered jaw reaches fasteners in narrow spaces with ease

PROD. NO.	MOD. NO.	Length	List	Sale
711152	AWP-6B	6"	\$32.70	\$18.95
711153	AWP-8B	8"	\$41.30	\$23.95
711154	AWP-10B	10"	\$48.20	\$27.95
711155	AWP-12B	12"	\$63.75	\$36.95
711156	AWP-15B	15"	\$120.65	\$69.95
711157	AWP-18B	18"	\$206.85	\$119.95
711159	AWP-24B	24"	\$344.85	\$199.95

## 1/2" Drive 250 ft/lb Torque Wrench

**SUPER SPECIAL**



**NEW**

- 24 Tooth Chrome Vanadium ratchet gear
  - Dual Ft/Lb and Nm scales
  - Scales hard stamped for permanent visibility
  - Deeply knurled handle provides safe, secure grip
  - Traditional knurled type handle lock securely retains setting
- 718915 JPRT-12250** | List \$172.40

**SALE \$99.95**

## Torque Wrenches



718902

- 24 tooth Chrome Vanadium ratchet gear (Chrome Molybdenum on 3/4" model)
- Reversible ratchet
- Dual ft/lb and Nm scales

PROD. NO.	MOD. NO.	Drive	Length	Torque Range	List	Sale
718902	JTW-1425	1/4"	13-3/4"	40 – 250 in-lb (6 – 30 Nm)	\$212.05	\$122.95
718908	JTW-3880	3/8"	15-1/4"	15 – 80 ft-lb (19 – 110 Nm)	\$231.00	\$133.95
718911	JTW-12150	1/2"	21"	30 – 150 ft-lb (40 – 210 Nm)	\$265.50	\$153.95
718912	JTW-12250	1/2"	25-1/2"	50 – 250 ft-lb (70 à 350 Nm)	\$336.20	\$194.95
718918	JTW-34600	3/4"	43"	100 – 600 ft-lb (140 – 700 Nm)	\$1,200.35	\$696.00
718922	JTW-10700	1"	48"	135 – 700 ft-lb (135 – 949 Nm)	\$1,757.40	\$999.95

## 1/2" DR Digital Torque Wrench



- Digital readout signals torque audibly and visually
- 12 multi coloured lights with beeper signal torque even when display cannot be read
- Measures torque in both directions
- Accurate to +/-2% CW, +/-3% CCW from 20% - 100% of scale
- Quickly converts between in/lb, ft/lb, cm/kg, and Nm scales
- Stores up to 9 torque values for quick access to commonly used settings
- Display tracks torque as it is applied or can be set to display peak torque
- Records up to 50 Peak Hold values for accurate record keeping
- Large handle features soft touch TPR grip for user comfort
- Industrial quality 36 tooth sealed ratchet head
- Simple intuitive menu
- Meets ISO 6789-1992 and ANSI specifications
- Blow mould case
- JET offers certified re-calibration service on torque wrenches
- LED lights signal torque

**718946 JDTW-12250** | List \$655.30

**SALE \$379.95**

## Torque Multiplier Kits - Heavy Duty

719071



719072

- Kit includes straight and 90° reaction bars with reaction base

PROD. NO.	MOD. NO.	Input Drive	Output Drive	Torque Ratio	Max. Input	Max. Output	List	Sale
719071	JTM-50750	1/2"	3/4"	3.3:1	227 ft-lb	750 ft-lb	\$913.95	\$529.95
719072	JTM-51100	1/2"	3/4"	6.5:1	170 ft-lb	1,100 ft-lb	\$1,517.60	\$879.95
719074	JTM-51850	1/2"	1"	12:1	154 ft-lb	1,850 ft-lb	\$1,895.40	\$1,099.00
719075	JTM-71850	3/4"	1"	3.3:1	560 ft-lb	1,850 ft-lb	\$1,517.60	\$879.95

## 1/2" DR 250 ft/lb Torque Wrench - Super Heavy Duty



- Magnified view window shows torque value in numbers only - no scale lines to read!
- Lifetime tested to 3 x ISO standards

**718962 JSHD-12250** | List \$431.05

**SALE \$249.95**

## 1/4" DR 50 in/lb Torque Screwdriver



- 10 – 50 in/lb
- 6" Length

**718991 JTSD-1450K** | List \$258.60

**SALE \$149.95**

## 14 PC Jumbo Handle Screwdriver Set

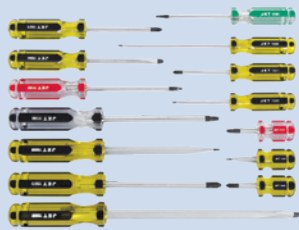

- CrV shafts
- Blow mould tray

720507 JHSS-14 | List \$153.40

**SALE \$88.95**

## 14 PC Cushion Grip Screwdriver Set



- Patented SVCM tool steel is up to 30% stronger than CrV screwdrivers
- Integrated cushion grips provide all day comfort and increase torque
- Slot stubby round shank 1/4" x 4", 5/16" x 6", 3/8" x 8"
- Slot square shank 1/4" x 4", 5/16" x 6", 3/8" x 8"
- Cabinet tip 3/16" x 3", 3/16" x 6"
- Phillips #1 x 3", #2 x 1-1/2", #2 x 4", #3 x 6"
- Square #1 x 4", #2 x 1-1/2", #2 x 4", #3 x 4"

720566 JKS-14S | List \$224.10

**SALE \$129.95**

## 6 PC Torque Drive® Screwdriver Set

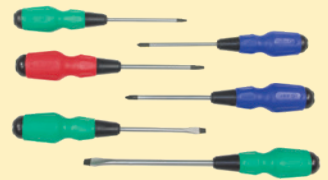

- Slot: 1/4 x 4", 5/16 x 6"
- Phillips: #1 x 4", #2 x 4"
- Square: #1 x 4", #2 x 4"
- Go thru shafts
- Ergonomic handles for non slip grip

720508 TDSS-6 | List \$67.15

**SUPER SPECIAL**

**SALE \$29.95**

## 9 PC Ergonomic Screwdriver Set



- Unique handle design conforms to the hand for exceptional comfort and grip
- Patented SVCM tool steel is up to 30% stronger than CrV screwdrivers

720523 JTSD-9S | List \$112.00

**SALE \$64.95**

## 7-In-1 Ratcheting Screwdriver with Bonus Mini Driver



- Bit Load:  
3/16", 1/4" Slot  
PH1, PH2  
T15, T20

720555 JRSD-2S | List \$68.90

**SALE \$39.95**

## 5 PC Spiral Screw Extractor Set



- Size range: 1/8" – 3/4"
- Chrome Molybdenum steel

H1365 | List \$31.55

**SALE \$17.95**

## 9 PC VDE Insulated Screwdriver Set

**SUPER SPECIAL**



- Electrically shielded tools for use on live circuits and hybrid automobiles
- Individually tested and VDE certified to 1,000V

760202 JISD-9S | List \$135.15

**SALE \$59.95**

## 6 PC Precision/TORX® Screwdriver Sets

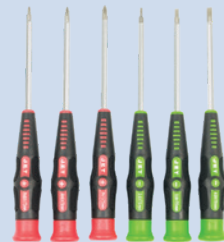

- 720542:  
• Slot: 2.0, 3.0, 4.0  
• Phillips: #00, #0, #1  
720544:  
• T5, T6, T7, T8, T9, T10

PROD. NO.	MOD. NO.	List	Sale
720542	JPSD-6	\$53.40	\$29.95
720546	JPSD-6T	\$56.85	\$32.95

## 5 PC Screw Extractor Set



- Size range: 1/4" – 5/8"
- Chrome Molybdenum steel

H1273 | List \$52.70

**SALE \$29.95**

## 15-in-1 Multi-Bit Screwdriver



- 7 double end bits give you 14 screwdriver tips
- S2 alloy steel bits Rockwell 59+/- 2HRC

H3400 | List \$49.15

**SALE \$27.95**

## 19 PC Ratcheting Screwdriver Set



- 8 double-ended screwdriver bits and 3 nut drivers

720590 JRSD-19 | List \$60.30

**SALE \$34.95**

## 11-in-1 Multi-Bit Screwdriver with Bonus Bottle Opener



- Bit load:  
• 3/16", 1/4" Slot  
• PH1, PH2  
• S1, S2  
• T10, T15

720538 JMBD-11BO | List \$34.40

**Bonus!**

**SALE \$19.95**

### 6.5" Heavy Duty Round Channel Bench Vise

- Round channel design keeps debris out and lubrication in for long life and easy operation
- Micro-grooved hardened replaceable machinist and pipe jaws provide safe, secure grip on a variety of materials
- Complete with 360° 4-point interlocking swivel base with dual lock down handles for firm support
- Vise nut is rear mounted for straight line pull and even pressure

**NEW**

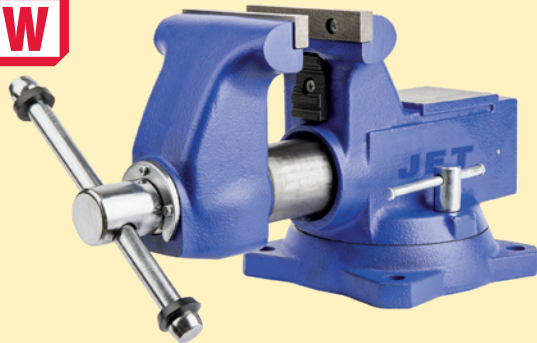

- Heavy duty 60,000 psi ductile iron casting for demanding applications

**320403** JBTV-6 | List \$388.00

**SALE \$299.95**

### British Pattern Bench Vises - Heavy Duty

- Exclusive integrated anvil provides extra work area for added versatility
- Heavy duty 30,000 psi ductile iron casting provides excellent strength and high clamping pressures
- Micro-grooved hardened replaceable machinist jaws provide safe, secure grip on a variety of materials

**NEW**

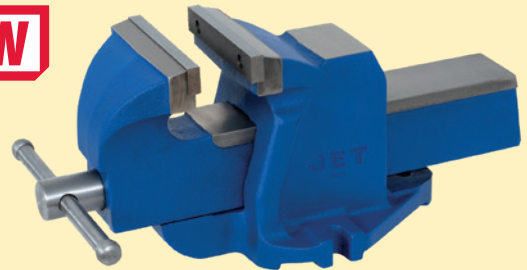

- Traditional British design

PROD. NO.	MOD. NO.	Jaw Width	Max. Opening	List	Sale
<b>320332</b>	JBPV-4	4"	4.75"	\$129.30	<b>\$99.95</b>
<b>320333</b>	JBPV-5	5"	6.75"	\$232.75	<b>\$179.95</b>
<b>320334</b>	JBPV-6	6"	8"	\$271.55	<b>\$209.95</b>
<b>320335</b>	JBPV-8	8"	9"	\$375.00	<b>\$289.95</b>

### 6" Bench Vise – Super Heavy Duty



- Up to 50% stronger than forged steel vises
- Adjustable guide rails take up wear and maintain smooth, parallel operation
- Micro-grooved hardened replaceable machinist and pipe jaws provide safe, secure grip on a variety of materials
- Complete with 360° 3-point ADI interlocking swivel base with dual lock down handles for firm support

**NEW**



- Super Duty 120,000 psi Austempered Ductile Iron (ADI) casting for extreme applications

**320503** JADV-6 | List \$452.65

**SALE \$349.95**

### 2.5" Portable Bench Vise

- Mounts securely to workbench or table top
- Round channel design keeps debris out and lubrication in for long life and easy operation
- Micro-grooved hardened replaceable jaws
- Swivel base for increased versatility

**NEW**

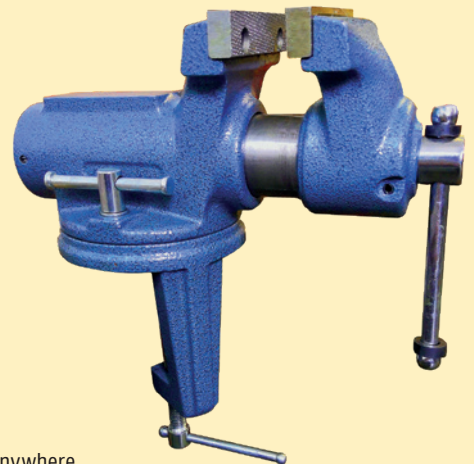

- Portable cast iron bench vise goes anywhere

**320449** JMBV-25 | List \$90.50

**SALE \$69.95**

**ALL OUR VISES COME WITH LIMITED LIFETIME WARRANTY**

### Aluminum Pipe Wrenches - Super Heavy Duty



- Chrome Molybdenum hook and heel jaws for longest life and maximum grip

PROD. NO.	MOD. NO.	Length	Jaw Capacity	List	Sale
710225	PWA-14	14"	2-7/16"	\$84.00	<b>\$64.95</b>
710227	PWA-18	18"	2-7/8"	\$106.00	<b>\$79.95</b>
710230	PWA-24	24"	3-3/16"	\$164.20	<b>\$119.95</b>
710236	PWA-36	36"	5-1/4"	\$336.25	<b>\$259.95</b>
710239	PWA-48	48"	6"	\$517.35	<b>\$399.95</b>

### Steel Pipe Wrenches - Super Heavy Duty



- Chrome Molybdenum hook and heel jaws for longest life and maximum grip

PROD. NO.	MOD. NO.	Length	Jaw Capacity	List	Sale
710122	PW-8	8"	1-3/16"	\$28.40	<b>\$19.95</b>
710123	PW-10	10"	1-13/16"	\$36.15	<b>\$27.95</b>
710124	PW-12	12"	2-7/16"	\$45.20	<b>\$34.95</b>
710125	PW-14	14"	2-7/16"	\$51.65	<b>\$39.95</b>
710127	PW-18	18"	2-7/8"	\$73.65	<b>\$56.95</b>
710130	PW-24	24"	3-3/16"	\$116.35	<b>\$89.95</b>
710136	PW-36	36"	5-1/4"	\$245.70	<b>\$189.95</b>

### C-Clamps - Heavy Duty



- Drop forged for maximum strength
- Heavy duty swivel pads

PROD. NO.	MOD. NO.	Max. Opening	Throat Depth	List	Sale
390102	CC-2	2-3/16"	1"	\$24.50	<b>\$18.95</b>
390103	CC-3	2-5/8"	1-1/2"	\$38.75	<b>\$29.95</b>
390104	CC-4	4"	1-3/4"	\$47.80	<b>\$36.95</b>
390105	CC-5	4-5/8"	2-1/16"	\$73.65	<b>\$56.95</b>
390106	CC-6	6-1/4"	2-1/2"	\$74.95	<b>\$57.95</b>
390108	CC-8	7-1/2"	3-1/4"	\$107.30	<b>\$82.95</b>
390110	CC-10	9-1/2"	4-1/4"	\$193.95	<b>\$149.95</b>
390112	CC-12	11-9/16"	4-1/2"	\$232.75	<b>\$179.95</b>

### L-Clamps - Heavy Duty



- Heavy Duty swivel pads

PROD. NO.	MOD. NO.	Opening	Throat Depth	List	Sale
390224	JLHD-8	8"	5-1/2"	\$125.40	<b>\$96.95</b>
390226	JLHD-10	10"	5-1/2"	\$139.65	<b>\$107.95</b>
390228	JLHD-12	12"	5-1/2"	\$146.10	<b>\$112.95</b>
390230	JLHD-16	16"	5-1/2"	\$157.75	<b>\$121.95</b>
390232	JLHD-20	20"	5-1/2"	\$184.90	<b>\$142.95</b>
390233	JLHD-24	24"	5-1/2"	\$200.40	<b>\$154.95</b>

### 42" Adjustable Head Creeper



- Six double post casters for easy maneuverability

355115 JAHC-643 | List \$151.25

**SALE \$99.95**

### 6 Wheel Mechanic's Creeper



- Made with 100% new High Density Polyurethane for unparalleled strength and long life – no recycled materials
- Generous shoulder relief allows unrestricted arm movement
- 6 large double post polyurethane casters with ball bearings provide a smooth ride over most shop floors

355130 JBMC-620 | List \$113.75

**SALE \$87.95**

**3/8" Drive Butterfly Impact Wrench - Heavy Duty**

**SUPER SPECIAL**

- Industry's hardest hitting butterfly wrench - 85 ft/lb of maximum torque in the palm of your hand!
- Heavy Duty swivel mounted air inlet for easy access to tight places

**400116 AW38BHD | List \$251.75**
**SALE \$159.95**
**3/8" Drive Composite Series Impact Wrench - Super Heavy Duty**

- Produces 360 ft/lb of nut wrenching torque in reverse
- "Push Through" Forward / Reverse control conveniently allows one hand directional change
- Super strong composite body
- Weighs only 2.82 lb

**400140 AW375CSDP | List \$334.75**
**SALE \$229.95**
**1/2" Drive Compact Impact Wrench - Heavy Duty**

- Compact and powerful, overall length: 4.3"
- Single handed operation
- 450 ft/lb max torque forward

**400266 AW500AMIHD | List \$254.70**
**SALE \$174.95**
**3/4" Drive Impact Wrench - Heavy Duty**

- Maximum torque: 1,000ft/lb
- Twin hammer impact mechanism provides more power and smooth, balanced impact blows

**400310 AW19THA | List \$746.70**
**SALE \$499.95**
**3/4" Drive Composite Series Impact Wrench - Super Heavy Duty**

- Produces 1,250 ft/lb of nut wrenching torque in reverse
- "Push Through" Forward / Reverse control conveniently allows one hand directional change
- Weighs only 7.74 lb

**400340 AW19CSDP | List \$807.55**
**SALE \$499.95**
**SUPER SPECIAL**
**.6 HP 1/4" 90° Angle Head Die Grinder - Heavy Duty**

- Rear exhaust, compact motor housing
- New improved drive gear system for longer life in heavy applications

**402113 MG90HD | List \$318.70**
**SALE \$229.95**
**.6 HP 1/4" Mini Die Grinder - Heavy Duty**

- Front exhaust, compact motor housing - only 5-3/4" long!

**402114 MG1HD | List \$156.55**
**SALE \$112.95**
**5" Angle Grinder - Heavy Duty**

- Spindle lock for easy accessory changes
- Adjustable swivel guard has 9 positive lock settings, no tools required
- 11,000 RPM

**402313 AG50HD | List \$574.95**
**SALE \$394.95**



## 3/8" Reversible Drill - Keyless Chuck - Heavy Duty



- Designed for heavy duty use this powerful yet compact air drill features a heat treated cylinder, two steel motor bearing plates, black oxide finished rotor and full cage planetary gear mechanism for maximum service life

404419 AD380HDR | List \$252.35

**SALE \$172.95**

## 1/2" Drill - Keyed Chuck



- Double reduction planetary gear system gives low speed and high torque for heavier drilling jobs
- Ball and needle bearing construction

404423 RDX-12 | List \$289.50

**SALE \$166.95**

## 1/2" Reversible Drill - Keyless Chuck - Heavy Duty



- Heavy duty motor with double reduction planetary gear system to 800 RPM provides exceptional power
- Reverse switch situated for fast and easy one handed operation

404424 AD12HDR | List \$365.20

**SALE \$249.95**

## Straight Type Flux Chipper - Heavy Duty



- Light-weight compact design allows maximum operator control and access to jobs in hard-to-reach areas

404203 FC250 | List \$332.55

**SALE \$219.95**

## .401 Shank Medium Barrel Air Hammer



- Medium barrel delivers steady powerful blows
- Accepts popular .401 taper shank chisels

404123 AH150M | List \$83.10

**SALE \$59.95**

## 3" Stroke .580 Hex Chipping Hammer - Heavy Duty



- This powerful and hard hitting tool offers the perfect balance of performance and life

404323 CH3H | List \$776.55

**SALE \$532.95**

## Retractable Air/Water Hose Reels - Heavy Duty



- Superior heavy gauge steel for professional use
- All metal parts powder coated for corrosion free performance

PROD. NO.	MOD. NO.	Inside Diameter	Hose Length	List	Sale
391721	AW3825	3/8"	25'	\$429.35	\$294.95
391722	AW3850	3/8"	50'	\$553.10	\$379.95

## Soft Rubber Tip Blow Gun Stub Nose - Super Heavy Duty



- Rubber tip design for use on soft materials that may get scratched if using a metal tip
- Special design has significantly less air consumption while producing maximum air outflow at the tip

409910 ABG-2SD | List \$45.65

**SALE \$28.95**

## 4" Angled Tip Safety Blow Gun - Heavy Duty



- The safety tip reduces air pressure to maximum 30 PSI
- Meets OSHA safety standards
- Brass inlet for longer life

409904 ABGO-4 | List \$17.95

**SALE \$12.95**

## 2-1/2 Ton Service Jack plus 3 Ton Vehicle Stands

**SUPER SPECIAL** **WHILE QUANTITIES LAST**

- Combo pack promotion of 2-1/2 Ton Service Jack & 3 Ton Safety Stands for a super low promo price.

030416 952B-SP | List \$375.50



**SALE \$224.95**

## 3 Ton 2xP Floor Jack

- 2xP – Double Pump design for fast efficient lifting
- Superior grade "soft" components for better performance in increased jack life
- Padded handle bumper protects vehicle finish

030417 953D | List \$349.30



**SALE \$239.95**

## 3-1/2 Ton Service Jack plus 4 Ton Vehicle Stands

**WHILE QUANTITIES LAST**

- Combo pack promotion of 3-1/2 Ton Service Jack & 4 Ton Safety Stands for a super low promo price

030420 965D-SP | List \$443.40



**SALE \$319.95**



## 3 Ton Jack Stands - Ratcheting Style - Heavy Duty

- Heavy duty stands feature notched saddles to accept unitized body configuration
- Sold and shipped in pairs

032241 853A | List \$87.25



**SALE \$59.95**

## 6 Ton Jack Stands - Ratcheting Style - Heavy Duty

- Heavy duty stands feature notched saddles to accept unitized body configuration
- Sold and shipped in pairs

032243 856A | List \$130.95



**SALE \$89.95**

## 1/2" Drive Composite Series Impact Wrench - Super Heavy Duty

**SHD**

- Produces 780 ft/lb of nut wrenching torque in reverse
- Will loosen a nut/bolt stuck at over 1,200 ft/lb in 15 - 20 seconds
- Weighs only 4.40 lb

400240 AW500CSDP | List \$363.85



**SALE \$249.95**

## 22 Ton Pin Style Jack Stand - Heavy Duty

**NEW**

- Four height adjusting pin positions
- Large support saddle
- 10" x 10" square base
- Sold individually

032230 878B | List \$303.85



**SALE \$219.95**

## 12 Ton Jack Stands - Ratcheting Style - Heavy Duty

- Heavy duty stands feature notched saddles to accept unitized body configuration
- Sold and shipped in pairs

032246 872B | List \$371.15



**SALE \$249.95**

## 1/2" Drive Impact Wrench - Heavy Duty

- Produces 550 ft/lb of hard hitting torque
- Weighs only 5.7 lb
- Twin Hammer mechanism provides more power and smooth, balanced impact blows for reduced vibration

400252 AW50AT | List \$218.30



**SALE \$149.95**

## 1" Drive Lightweight Impact Wrench - Super Heavy Duty (6" Extended Anvil)

**SHD**

- Produces an incredible 2,100 ft/lb of nut wrenching torque in reverse
- Ultimate power in reverse maximizes removal of stubborn rusted nuts
- Weighs only 24 lb – unheard of power to weight performance – compare traditional models at over 30 pounds
- Lightweight "Back Saver Technology" ensures maximum operator comfort and safety, and minimum fatigue during use

400444 AW25ASD6 | List \$1,193.65



**SALE \$819.95**

## 1" Drive D-Handle Impact Wrench (6" Extended Anvil)

- Produces 1,900 ft/lb of hard hitting torque
- Rocking dog hammer mechanism for power and durability
- 6" extended anvil to access lug nuts in truck and tractor wheels

400456 AW25AD6 | List \$684.15



**SALE \$469.95**

## 3/8" Hybrid Air Hoses



- Polymer construction for the heaviest duty applications
- UV, ozone, and chemical resistance for longevity
- 300 PSI max working pressure, 1,200 PSI burst pressure
- Temperature range: -40°C (-40°F) to +82°C (180°F)

PROD. NO.	MOD. NO.	Hose Length	List	Sale
408193	AH3825HY	25'	\$55.35	<b>\$39.95</b>
408194	AH3850HY	50'	\$83.10	<b>\$59.95</b>

## Industrial Series Torque Wrenches



718976

- All metal construction for the toughest, most demanding industrial applications
- Chrome Molybdenum ratchet pawls and teeth heat treated for maximum durability and high torque loads
- Quick release ratchet head holds sockets and accessories safely and securely
- Accurate to +/-3% clockwise and +/-6% counterclockwise

PROD. NO.	MOD. NO.	Drive	Length	Torque Range	List	Sale
718971	JITW-14250	1/4"	9-3/4"	50 – 250 in-lb (6.8 – 27.1 Nm)	\$258.60	<b>\$149.95</b>
718973	JITW-38100	3/8"	17"	20 – 100 ft-lb (33.9 – 128.8 Nm)	\$310.35	<b>\$179.95</b>
718976	JITW-12250	1/2"	24"	50 – 250 ft-lb (75 – 332 Nm)	\$344.85	<b>\$199.95</b>
718977	JITW-34600	3/4"	48-7/8"	150 – 600 ft-lb (237 – 779 Nm)	\$1,293.40	<b>\$749.95</b>
718980	JITW-101000	1"	72-7/8"	200 – 1,000 ft-lb (305 – 1,322 Nm)	\$2,586.85	<b>\$1,499.95</b>

## 1/2" Hybrid Air Hose - Super Heavy Duty



- Polymer construction for the heaviest duty applications
- UV, ozone, and chemical resistance for longevity
- 300 PSI max working pressure, 1,200 PSI burst pressure
- Temperature range: -40°C (-40°F) to +82°C (180°F)

PROD. NO.	MOD. NO.	Hose Length	List	Sale
408195	AH1225HY	25'	\$69.20	<b>\$49.95</b>
408196	AH1250HY	50'	\$124.65	<b>\$89.95</b>

## 5 PC 1/2" DR Torque Limiting Impact Extension Set



- Flexes to limit torque
- CrMo Steel

682961 JTLE-5S | List \$172.40



SALE **\$79.95**

## 5 PC 1/2" DR Mag Wheel Impact Socket Set



- 13/16 – 7/8", 17 – 21 mm
- Colour coded for identification

610341 MWPS-512 | List \$137.90



SALE **\$59.95**

## Air Line Inflator With Tire Gauge



- Lever action tool inflates tires and measures pressure levels
- 360° swivel dual head chuck prevents tangling air hose
- Measures 10 – 90 psi in 2 lb increments
- Chrome plated zinc body with brass internal parts for resistance to corrosion
- Includes 1/4" x 12" air hose rated to 300 psi

H3282 | List \$109.00

SALE **\$62.95**

## Tire Tread Depth Gauge



- Accurately determines amount of tread left on tire
- Maximum tread depth measured 1" (25 mm)
- 3 sides calibrated in 1/32" increments
- 3 sides calibrated in 1 mm increments
- Chrome plated brass body
- Handy pocket clip

H1151 | List \$15.75

SALE **\$8.99**

## Valve Core Tool



- Removes and installs standard size valve cores
- Aluminum handle provides sturdy grip
- Overall length 5"

H1147 | List \$26.30

SALE **\$14.95**

## Air Line Inflator With Tire Gauge - Dial Type



- 3-in-1 tool, air line inflator & deflator with tire pressure gauge
- Heavy duty construction provides long service life

H3284 | List \$235.60

SALE **\$136.95**

## Digital Tire Pressure Gauge



- Large easy to read LCD display with built in backlight
- Audible buzzer indicates measurement has been made when screen is not visible
- 360° swivel head makes reaching any valve easier
- Measures up to 150 psi
- Measures psi, Bar, Kg/cm<sup>2</sup>, and kPa

H3276 | List \$84.35

SALE **\$48.95**

## 9-3/4" Wheel Weight Pliers



- Removes and installs all types of clip-on wheel weights

H1116 | List \$61.50

SALE **\$35.95**

**Bottle Jacks - Heavy Duty**



030102

030103



030105

030104

030106



030107



030110



030111



030112



030114



030115

**SUPER SPECIAL**

- Factory pre-tested to 150% of rated capacity
- Heavy duty steel saddle for secure lifts
- Heat treated piston for maximum strength

PROD. NO.	MOD. NO.	Capacity	Low Height	High Height	Lift	List	Sale
030102	302A	2 T	6-1/4"	12-1/2"	3-3/4"	\$44.30	<b>\$29.95</b>
030103	304A	4 T	6-3/4"	12-1/4"	3-1/4"	\$60.90	<b>\$39.95</b>
030104	306A	6 T	8"	16"	5-1/4"	\$69.20	<b>\$45.95</b>
030105	308A	8 T	7-3/4"	15-3/4"	5-1/4"	\$98.35	<b>\$64.95</b>
030106	312A	12 T	8-1/2"	17"	5-3/4"	\$126.05	<b>\$83.95</b>
030107	314A	12 T	7"	13"	4"	\$126.05	<b>\$83.95</b>
030110	320A	20 T	9-1/2"	18-1/4"	6-1/4"	\$177.30	<b>\$117.95</b>
030111	322A	20 T	7-3/4"	14-3/4"	4-1/2"	\$177.30	<b>\$117.95</b>
030112	330A	30 T	11-1/4"	18-3/4"	7-1/2"	\$442.45	<b>\$279.95</b>
030114	350A	50 T	11-3/4"	19-3/4"	8"	\$713.25	<b>\$449.95</b>
030115	352A	50 T	11-3/4"	19-3/4"	8"	\$854.45	<b>\$557.95</b>

**2 Ton 2xP Low Profile Floor Jack**



- Low Profile – 75 mm (2.95")
- 2xP – Double Pump design for fast efficient lifting
- Superior grade "soft" components for better performance in increased jack life

030404 962DL | List \$436.65

**SALE \$299.95**

**Service Jacks - Heavy Duty**

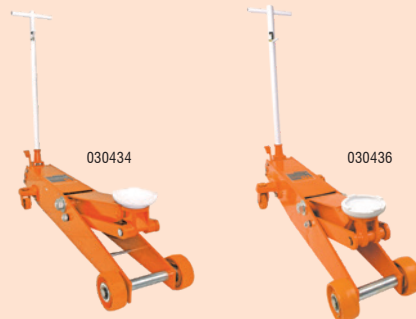

030434

030436

- Automatic safety valve prevents overload
- Heavy duty swivel casters provide optimum manoeuvrability

PROD. NO.	MOD. NO.	Capacity	List	Sale
030434	955	5 T	\$1,455.65	<b>\$999.95</b>
030436	957	10 T	\$1,886.55	<b>\$1,295.95</b>

**Air/Hydraulic Service Jacks - Heavy Duty**

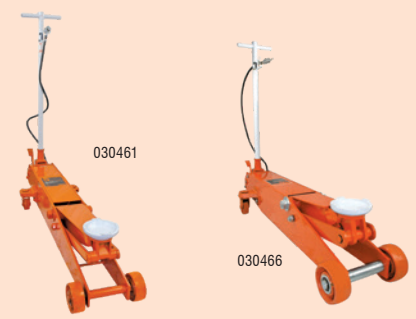

030461

030466

- Automatic safety valve prevents overload
- Heavy duty swivel casters provide optimum manoeuvrability

PROD. NO.	MOD. NO.	Capacity	List	Sale
030461	956	5 T	\$2,021.95	<b>\$1,388.95</b>
030466	959	10 T	\$2,460.15	<b>\$1,689.95</b>

## 1 Ton - 2 stage Hydraulic Transmission Jack w/Bonus Fuel Tank Removal Adapter

- Adjustable brackets, 2 safety straps and 2 grounding cables
- Overall Width: 15", Retracted Length: 19-3/4", Extended Length: 31-3/4", Pad Size: 5-3/4" x 4"
- STRONGARM Hydraulic Telescopic Transmission Jacks provide service technicians one-man capabilities for installing transmissions, differentials or transfer case
- Telescopic two-stage hydraulics for greater lift range, precise load control and rapid lift
- Extendable height from 37" to 76 3/8"



030539 | List \$1,773.80

**SALE \$1,279.95**

## 1/2 Ton High Lift/Air Transmission Jacks



PROD. NO.	MOD. NO.	1st Stage	2nd Stage	List	Sale
030535	814B	19-3/8"	20"	\$1,324.65	\$909.95
030536	814BA	19-3/8"	20"	\$1,780.30	\$1,219.95

## 2 Ton Low Profile Transmission Jack - Super Heavy Duty



- STRONGARM offers the only Super Heavy Duty transmission jack with a full 2 ton capacity
- Low Height: 8-1/2", High Height: 34"

030549 808A | List \$3,049.70

**SALE \$2,099.95**

## Wheel Dolly



- Handles wheels up to 24" diameter safely and easily
- Design enables one person to do the work without lifting or straining
- 13-3/4" long rollers allow easy wheel to hub alignment

030485 624A | List \$211.95

**SALE \$139.95**

## 1.2 Ton Large Wheel Removal Dolly



- For removing, transporting, and mounting large off-road tractor / wheeled excavator tires easily and safely
- For large wheels from 39" (1m) up to 86" (2.2m) in diameter and up to 31" (.8m) in cross-section width

030487 WDX12 | List \$2,210.40

**SALE \$1,594.95**

## Brake Drum Handler - Heavy Duty



- Accommodates 15" to 16-1/2" brake drums
- Handles both outboard and inboard drums

030483 623 | List \$551.50

**SALE \$397.95**

## 1,000 lb H-Design Engine Stand



- Wide 4 point H type base ensures good stability
- 4 Adjustable brackets provide maximum flexibility - fits most small engines
- 360° rotating head enables engine to be placed in desired work position
- 2 fixed rear wheels and 2 front swivel casters
- Heavy duty welded reinforced steel base

030352 234B | List \$277.95

**SALE \$190.95**

## 2 Ton Engine Crane - Heavy Duty



- Swivel hook on boom for better manoeuvrability
- Telescopic boom provides 4 adjustments

030315 216 | List \$983.00

**SALE \$709.95**

## Clutch Jack - Heavy Duty



- A highly efficient design that provides the technician with capabilities to remove, install and transport heavy duty truck clutches
- Pump handle rotates 360° for ease of operation in virtually any work position
- Low Height: 13", High Height: 39"

030501 802A | List \$1,171.80

**SALE \$804.95**



**Buy Tool Storage Combos and SAVE!**



## The Best Value for Tool Storage in Canada!

- Double wall steel construction with reinforced bottom channels on both cabinets and chests
- 100 lb capacity ball bearing slides on most drawers **A** (75 lb on 27" models)
- Gas struts on top chests (27" excluded) **B**
- Select drawers with 2 sets of slides to accommodate heavier loads
- Centre slide on full width drawer supports heavier loads (56" and 72" only)
- Roller cabinets include wood tops from a renewable resource **C**
- Power supply management includes 4 AC and 2 USB outlets on roller cabinets (27" excluded) **D**
- Heavy duty casters with pedal brake **E**
- Extruded aluminum drawer pulls ensure positive grip when opening heavily loaded drawers
- Riveted aluminum mouldings protect box corners from impact (27" excluded)

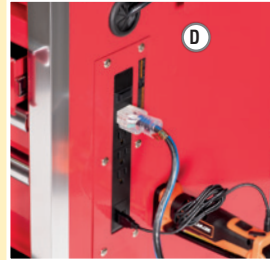
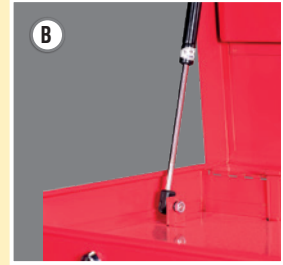
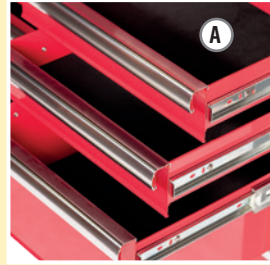

**SAVE 30% OFF List Price when you buy combos!**



842954 **Pro Series 27" 13 Drawer Tool Storage Combo**

**NEW**

842503 PRC2707 Cabinet  
842553 PMC2706 Chest

**SALE \$899.95**

842955 **Pro Series 41" 21 Drawer Tool Storage Combo**

**NEW**

842514 PRC4211 Cabinet  
842564 PMC4210 Chest

**SALE \$1,299.95**

842956 **Pro Series 56" 16 Drawer Tool Storage Combo**

**NEW**

842524 PRC5610 Cabinet  
842574 PMC5606 Chest

**SALE \$1,999.95**

# The Best Value for Tool Storage in Canada!



- Double wall steel construction with reinforced bottom channels on both cabinets and chests
- 100 lb capacity ball bearing slides on most drawers (75 lb on 27" models)
- Select drawers with 2 sets of slides to accommodate heavier loads
- Centre slide on full width drawer supports heavier loads (56" and 72" only)
- Power supply management includes 4 AC and 2 USB outlets on roller cabinets (27" excluded)
- Extruded aluminum drawer pulls ensure positive grip when opening heavily loaded drawers
- Riveted aluminum mouldings protect box corners from impact (27" excluded)
- Heavy duty casters with pedal brake
- Roller cabinets include wood tops from a renewable resource
- Gas struts on top chests (27" excluded)

## Pro Series Roller Cabinet - 15 Drawers - 72" x 24"

**NEW**



PROD. NO.	MOD. NO.	Load Rating	Storage Capacity	Weight	List	Sale
842531	PRC7215	3,000 lb	30,842.8 cm <sup>3</sup>	518 lb	\$2,982.35	<b>\$2,195.95</b>

## Pro Series Mechanic's Chest - 6 Drawers - 56" x 24"

**NEW**



PROD. NO.	MOD. NO.	Load Rating	Storage Capacity	Weight	List	Sale
842574	PMC5606	600 lb	12,644.6 cm <sup>3</sup>	192 lb	\$951.00	<b>\$699.95</b>

## Pro Series Roller Cabinet - 10 Drawers - 56" x 24"

**NEW**



PROD. NO.	MOD. NO.	Load Rating	Storage Capacity	Weight	List	Sale
842524	PRC5610	1,800 lb	23,872.8 cm <sup>3</sup>	379 lb	\$1,900.80	<b>\$1,399.95</b>

## Pro Series Mechanic's Chest - 10 Drawers - 42" x 18"

**NEW**



PROD. NO.	MOD. NO.	Load Rating	Storage Capacity	Weight	List	Sale
842564	PMC4210	1,000 lb	6,608 cm <sup>3</sup>	122 lb	\$706.45	<b>\$519.95</b>

## Pro Series Roller Cabinet - 11 Drawers - 42" x 18"

**NEW**



PROD. NO.	MOD. NO.	Load Rating	Storage Capacity	Weight	List	Sale
842514	PRC4211	1,300 lb	12,464.6 cm <sup>3</sup>	200 lb	\$1,046.15	<b>\$769.95</b>

## Pro Series Mechanic's Chest - 6 Drawers - 27" x 18"

**NEW**



PROD. NO.	MOD. NO.	Storage Capacity	Weight	List	Sale
842553	SMC2706	5,991 in <sup>3</sup>	78 lb	\$529.80	<b>\$389.95</b>

## Pro Series Roller Cabinet - 7 Drawers - 27" x 18"

**NEW**



PROD. NO.	MOD. NO.	Weight	Wheels	List	Sale
842503	SRC2707	117 lb	5" x 1-1/4", 2 swivels, 2 fixed	\$706.45	<b>\$519.95</b>

# The New Standard for Professional Tool Storage!



- Double wall 18 gauge steel construction with 14 gauge reinforced bottom channels withstands the heaviest loads
- 120 lb capacity ball bearing slides on all drawers for smooth, easy operation even when heavily loaded
- Select drawers with 2 sets of slides to accommodate heavier loads – up to 240 lb
- Soft-Close drawer slides prevent slamming the drawers closed, keeping tools organized and ensuring drawers are completely closed before locking or moving tool box (A)

- Gas shocks support chest lids (B)
- Lowered till height allows easy access to tools in top chests
- Heavy duty automotive style casters with pedal brake (C)
- USB-powered LED lighting in 41" and 52" top chests
- Power supply management includes 4 AC and 2 USB outlets with switch on all roller cabinets and top chests (6 outlets on 72" cabinet) (D)

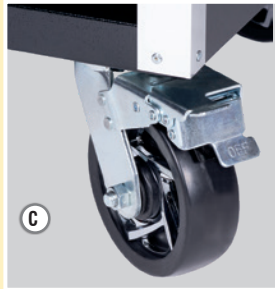

## HD Series Mechanic's Chest - 6 Drawers - 28" x 21"

**NEW**



PROD. NO.	MOD. NO.	Load Rating	Storage Capacity	Weight	List	Sale
842655	HDMC2806	800 lb	7,790 cm <sup>3</sup>	143 lb	\$1,072.00	\$789.95

## HD Series Roller Cabinet - 12 Drawers - 41" x 21"

**NEW**



PROD. NO.	MOD. NO.	Load Rating	Storage Capacity	Weight	List	Sale
842615	HDFC4112	1,800 lb	17,202 cm <sup>3</sup>	307 lb	\$1,900.80	\$1,399.95

## HD Series Mechanic's Chest - 6 Drawers - 41" x 21"

**NEW**



PROD. NO.	MOD. NO.	Load Rating	Storage Capacity	Weight	List	Sale
842665	HDMC4106	800 lb	12,099 cm <sup>3</sup>	191 lb	\$1,248.65	\$899.95

## HD Series Roller Cabinet - 12 Drawers - 52" x 21"

**NEW**



PROD. NO.	MOD. NO.	Load Rating	Storage Capacity	Weight	List	Sale
842622	HDFC5212	1,800 lb	22,499 cm <sup>3</sup>	371 lb	\$2,349.20	\$1,699.95

## HD Series Mechanic's Chest - 6 Drawers - 52" x 21"

**NEW**



PROD. NO.	MOD. NO.	Load Rating	Storage Capacity	Weight	List	Sale
842672	HDMC5206	800 lb	15,335 cm <sup>3</sup>	220 lb	\$1,887.25	\$1,399.95



## Jobsite Tool Storage Boxes - Super Heavy Duty



**NOW**  
with Gas  
Shocks

- Super Heavy Duty 16 gauge steel body and lid for maximum security

PROD. NO.	MOD. NO.	Storage Capacity	List	Sale
842480	JSB-3219	4.5 ft³	\$489.05	<b>\$359.95</b>
842481	JSB-4824	16.0 ft³	\$760.80	<b>\$559.95</b>

## 30" x 19" 4 Drawer Service Cart - Heavy Duty



- Plastic corner bumpers protect auto finishes
- Heavy gauge steel shell

842916 JTC-30194 | List \$774.40

**SUPER SPECIAL**

**SALE \$499.95**

## Lever Grease Gun - Heavy Duty



- Includes rigid hose
- 3 way loading capability

350152 JLGG-14HD | List \$53.80

**SALE \$36.95**

## Barrel Pump - Rotary - Heavy Duty



- Cast iron body
- Pumps in either direction

350103 HRP-25 | List \$145.50

**SALE \$99.95**

## Lever Bucket Pump



- Fits 25 - 50 lb / 5 gallon pails
- For transmission, differential, and heavier oils

350106 JLBP-02 | List \$110.80

**SALE \$79.95**

## Pistol Grip Grease Gun - Heavy Duty



- Includes 4" rigid hose & 18" flex hose

350155 JPGG-14HD | List \$72.70

**SALE \$49.95**

## 120 lb Air Operated Grease Pump Kit - Heavy Duty



- Pumps up to 1.76 lb per minute (27 ounces)
- Comes with 4 wheel roll around cart

350307 JAGP-120 | List \$1,288.80

**SALE \$929.95**

## 24 US Gallon (90 Litre) Waste Oil Drain - Heavy Duty



- 78" long drainage hose
- Tank mounted oil-level sight gauge

350511 JOIDR90 | List \$789.90

**SALE \$569.95**

## All-Weather Pistol Grip Grease Gun - Heavy Duty



- Specially designed to outperform in cold weather
- 7,500 PSI; 1oz/40 strokes

350165 JPGG-14AW | List \$69.20

**SALE \$49.95**

**4" x 6" Horizontal/Vertical Bandsaw**



- Sturdy cast iron saw frame and base
- 1/3 HP motor shuts off automatically when the workpiece is cut through
- Three speeds permit cutting of most materials including metal, plastic and wood
- Designed for horizontal and vertical cutting

**222326 JHVB-46** | List \$1,205.65

**SALE \$889.95**

**Bench Grinders - Heavy Duty**



PROD. NO.	MOD. NO.	Motor	Amperage	RPM	Wheel Size	List	Sale
240153	BGC-6	1/3 HP, 1 ph, 115 V	3.5 A, 60 Hz	3,450	6" x 3/4" x 1/2"	\$271.65	<b>\$199.95</b>
240154	BGC-8	1/2 HP, 1 ph, 115 V	5 A, 60 Hz	3,600	8" x 1" x 5/8"	\$366.80	<b>\$269.95</b>

**7" x 12" Horizontal Bandsaw**



- Heavy duty cast iron construction for accuracy and durability
- Three speed gear box replaces less efficient belt drive systems found on most comparable machines
- Horizontal cutting feed rate controlled by a fully adjustable hydraulic ram

**222332 JHVG-712** | List \$3,698.90

**SALE \$2,699.95**

**17" 1 HP 16 Speed Floor Drill Press**

- Powerful 1 horse power motor
- Full 17" swing for easy drilling of larger work pieces
- 16 speed capability allows for a broad assortment of drilling applications
- Safety on/off switch with removable lock key
- Fully hinged belt and pulley cover and quick adjust motor mount permit fast changes of spindle speed
- Worktable with quick release clamp rotates and tilts to 45° right and left
- Slots in worktable and base permit easy clamping of the work piece
- Positive depth setting mechanism uses a threaded rod and two lock nuts for accuracy
- Built-in work lamp with separate switch (bulb not included) Standard Equipment: Drill chuck and key

**200278 JDP-17F** | List \$1,467.30

**SALE \$1,079.95**



**4" Drill Press Vise - Heavy Duty**

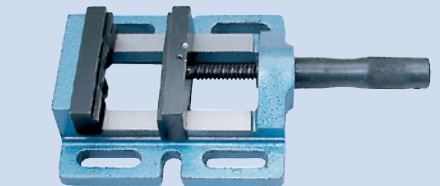

- Accurately ground base and slides
- Uni-grip mechanism allows powerful clamping force with minimal effort
- Eliminates need for crossbars or drop away handles
- Replaceable jaws hold round objects with ease

**321124 DPV-4U** | List \$178.45

**SALE \$137.95**

**9" x 16" Horizontal Bandsaw**



- Designed for industrial use, this saw features a heavy duty steel and cast iron saw frame
- One piece cast iron saw bed
- Enclosed base, welded for strength
- Precision cast 13" blade wheels

**222335 JHBS-916** | List \$8,446.90

**SALE \$5,999.95**

**13-1/2" 3/4 HP 12 Speed Floor Drill Press**

- Powerful 3/4 horse power motor
- 12 speed capability allows for a broad assortment of drilling applications
- Safety on/off switch with removable lock-out key
- Fully hinged belt and pulley cover and fully adjustable motor mount permit fast changes of spindle speed
- Worktable with quick release clamp rotates and tilts to 45° right and left
- Slots in worktable and base permit easy clamping of the work piece
- Positive depth setting mechanism uses a threaded rod and two lock nuts for accuracy
- Built-in work lamp with separate switch (bulb not included) Standard Equipment: Drill chuck and key

**200275 JDP-13F** | List \$937.45

**SALE \$689.95**



**20 Gallon Parts Washers - Heavy Duty**

- Fusible link melts and closes lid in the event of a fire, minimizing danger to workers and property
- 41.8 litre working capacity
- Flexible delivery spout
- Screened inlet protects pump from foreign material
- cETL certified to CAN/CSA C22.2 No. 68-92
- For use with water based cleaning solutions with ph of 7-8 only

PROD. NO.	MOD. NO.	Tank Dimensions	List	Sale
355007	JPW-20	29-7/8" x 20-3/4" x 10-5/8"	\$366.80	<b>\$269.95</b>



## KLP Series Lever Chain Hoists - Heavy Duty



- Industrial grade
- Grade 100 load chain
- Cast steel safety latches exceed industry standards

PROD. NO.	MOD. NO.	Standard Lift	List	Sale
110803	KLP-25-5	5'	\$311.75	<b>\$224.95</b>
110804	KLP-50-5	5'	\$394.90	<b>\$284.95</b>

## JET Universal Plate Clamps

**SUPER  
SPECIAL**



- Tested to 200% of rated capacity

PROD. NO.	MOD. NO.	Rated Lifting Capacity	List	Sale
109322	JPCU-50	1/2 T	\$168.35	<b>\$111.95</b>
109323	JPCU-100	1 T	\$252.60	<b>\$167.95</b>
109325	JPCU-200	2 T	\$335.35	<b>\$222.95</b>
109327	JPCU-300	3 T	\$482.40	<b>\$319.95</b>

## Hand Cable Pullers - Heavy Duty

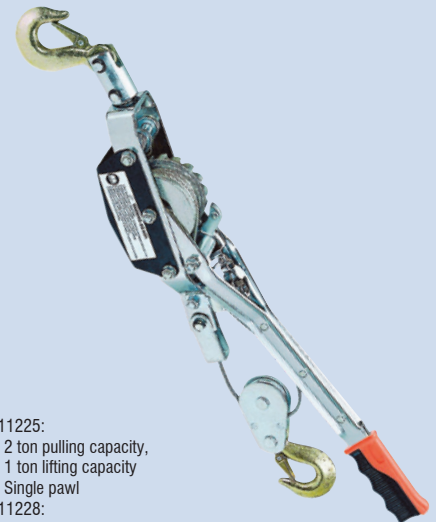

111225:

- 2 ton pulling capacity,
- 1 ton lifting capacity
- Single pawl

111228:

- 4 ton pulling capacity,
- 2 ton lifting capacity
- Dual pawls for added safety

PROD. NO.	MOD. NO.	Rated Lifting Capacity	List	Sale
111225	JCPP-200	1 T	\$90.00	<b>\$64.95</b>
111228	JCPP-400D	2 T	\$162.10	<b>\$116.95</b>

## Water Pumps



- Commercial grade aluminum housing
- Cast iron impeller and volutes

PROD. NO.	MOD. NO.	Inlet or Discharge	Sale
291037	JWP20L	2" NPT	<b>\$425.45</b>
291038	JWP30L	3" NPT	<b>\$459.70</b>
291039	JWP40L	4" NPT	<b>\$856.20</b>

## Generators



PROD. NO.	MOD. NO.	Generator	Sale
291102	JGE4200	4,200 Watt	<b>\$827.20</b>
291103	JGE6500E	6,500 Watt	<b>\$1,392.00</b>
291105	JGE9000E	9,000 Watt	<b>\$1,595.60</b>

## 3,500 Watt Electric Start Inverter



- 3,500-watt peak and 3,000-watt running power
- 10 litre fuel tank runs the generator continuously for up to 15 hours @ 50% rated load
- 212 cc, 4-stroke engine runs on gasoline to provide dependable power

PROD. NO.	MOD. NO.	Generator	Sale
291109	JIN3500E	3,500 Watt	<b>\$1,631.00</b>

## POWER-XTREME T1 Cut-Off Wheels

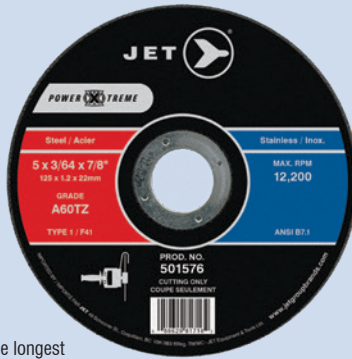
**TYPE 1**

- These wheels are manufactured with the most advanced technology of grains, bonds and reinforcements offering fast, cool, burn free cutting of steel and stainless steel
- Specially designed technology ensures the longest life and best performance in its class

PROD. NO.	Size	Grade	List	Sale
501571	4-1/2" x 3/64" x 7/8"	A60PX	\$4.00	\$2.90
501576	5" x 3/64" x 7/8"	A60PX	\$4.30	\$3.10
501581	6" x 3/64" x 7/8"	A60PX	\$5.45	\$3.95

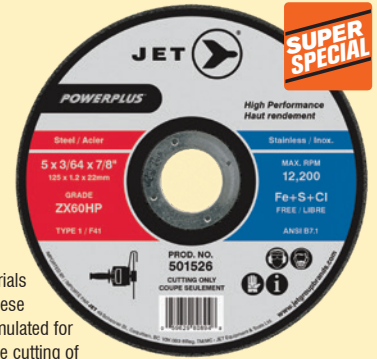

## POWERPLUS T1 Cut-Off Wheels

**TYPE 1**

- Designed for high performance cutting of steel and stainless steel materials
- Made from highly refined ingredients; these Fe+S+Cl free wheels are specially formulated for cutting steel and contamination/burn free cutting of all stainless steels

PROD. NO.	Size	Grade	List	Sale
501521	4-1/2" x 3/64" x 7/8"	ZX60HP	\$3.15	\$1.75
501526	5" x 3/64" x 7/8"	ZX60HP	\$3.30	\$1.90
501531	6" x 3/64" x 7/8"	ZX60HP	\$4.70	\$2.80



## POWERPLUS T27 Grinding Wheels

**TYPE 27**

- Specially formulated for high performance grinding in a wide range of steel grinding operations
- Made with high quality abrasive grains for faster grinding results with less effort

PROD. NO.	Size	Grade	List	Sale
500418	4-1/2" x 1/4" x 7/8"	A24R	\$4.40	\$3.15
500428	5" x 1/4" x 7/8"	A24R	\$4.75	\$3.45
500432	6" x 1/4" x 7/8"	A24R	\$6.55	\$4.75



## POWERPLUS T1 Cut-Off Wheels

**TYPE 1**

- Excellent for cutting all steel materials, offering outstanding cutting speed and long life

PROD. NO.	Size	Grade	List	Sale
501061	3" x 1/32" x 3/8"	A60	\$2.45	\$1.75
501062	3" x 1/16" x 3/8"	A60	\$2.45	\$1.75



## POWERBLEND TRM T29 Trimmable Zirconia Flap Discs

**TYPE 29**

- These premium high performance zirconia grain discs ensure fast, cool cutting action and extra long life on steel and stainless steel
- Exceptional durability, POWERBLEND TRM discs outlast traditional resin fibre discs up to 25 times - saving time and money

PROD. NO.	Size	Grit	List	Sale
503413	4-1/2" x 7/8"	Z40	\$9.65	\$6.45
503415	4-1/2" x 7/8"	Z60	\$9.65	\$6.45
503417	4-1/2" x 7/8"	Z80	\$9.65	\$6.45
503419	4-1/2" x 7/8"	Z120	\$9.65	\$6.45
503423	5" x 7/8"	Z40	\$11.00	\$7.35
503425	5" x 7/8"	Z60	\$11.00	\$7.35
503427	5" x 7/8"	Z80	\$11.00	\$7.35
503429	5" x 7/8"	Z120	\$11.00	\$7.35



## POWERBLEND EDG Flap Discs

**TYPE 29**

- New POWERBLEND EDG Super High Performance flap discs are folded upwards at a 90° angle to achieve optimal results in grinding fillet welds, corners, and other hard to reach places
- Made from specially formulated ceramic grains that are designed to stay sharp, ensuring faster stock removal rates and longer wheel life
- Fillet and corner grinding MADE EASY

PROD. NO.	Size	Grit	List	Sale
503865	4-1/2" x 7/8"	CG60	\$20.10	\$14.50
503875	5" x 7/8"	CG60	\$21.65	\$15.60



### JET-KUT® B & G Premium M2 H.S.S. Prentice Drill Bits

- Professional grade M2 High Speed Steel Bits
- Bronze oxide gold lands to reduce friction for cooler cutting and longer bit life
- TORQUE DRIVE® three ground flats eliminate chuck slippage

PROD. NO.	Size	Shank Diameter	List	Sale
571233	33/64"	1/2"	\$20.75	\$14.95
571234 <b>NEW</b>	17/32"	1"	\$21.60	\$15.60
571235	35/64"	1/2"	\$22.80	\$16.45
571236 <b>NEW</b>	9/16"	1"	\$23.95	\$17.30
571237	37/64"	1/2"	\$24.90	\$17.95
571238 <b>NEW</b>	19/32"	1/2"	\$25.85	\$18.65
571239 <b>NEW</b>	39/64"	1/2"	\$26.95	\$19.45
571240 <b>NEW</b>	5/8"	1"	\$27.65	\$19.95
571241	41/64"	1/2"	\$30.45	\$21.95
571242 <b>NEW</b>	21/32"	1"	\$30.35	\$21.90
571243	43/64"	1/2"	\$34.60	\$24.95
571244 <b>NEW</b>	11/16"	1"	\$33.20	\$23.95
571245	45/64"	1/2"	\$36.80	\$26.55
571246 <b>NEW</b>	23/32"	1/2"	\$38.20	\$27.55
571247 <b>NEW</b>	47/64"	1/2"	\$39.15	\$28.25
571248 <b>NEW</b>	3/4"	1"	\$37.20	\$26.85
571249	49/64"	1/2"	\$41.50	\$29.95
571250 <b>NEW</b>	25/32"	1/2"	\$42.90	\$30.95
571251 <b>NEW</b>	51/64"	1/2"	\$45.00	\$32.45
571252 <b>NEW</b>	13/16"	1"	\$43.10	\$30.95
571256	7/8"	1"	\$46.30	\$32.95
571260	15/16"	1"	\$50.55	\$36.50
571264	1"	1"	\$64.65	\$46.95
571268	1-1/16"	1/2"	\$72.85	\$52.95



### 29 PC JET-KUT® Black Oxide Drill Bit Set - General Purpose (For Steel/Wood)



- 135° Split Point
- Black Oxide Finish
- Available in popular 29 piece format with strong metal index box to protect and organize your bits



570108 29CD | List \$128.80

SALE

\$55.95

### 29 PC JET-KUT® B & G Jobber Length Drill Bit Set - Premium Quality

- Professional grade M2 high speed steel bits
- Bronze oxide gold ends to reduce friction for cooler cutting and longer bit life
- Nitro carburized black flutes for improved surface hardness ensure bit stays sharp longer
- 135° split point eliminates "walking"
- TORQUE DRIVE® three ground shanks eliminate chuck slippage



570146 BG29 | List \$142.70

SALE

\$99.95

### JET-KUT® 5 PC File Set - Premium

- Set includes 1 of each:
- 531410 10" Half Round Bastard
  - 531510 10" Mill Bastard
  - 531308 8" Flat Bastard
  - 531548 8" Mill Smooth
  - 532522 6" Slim Taper

532811 JFS-5V | List \$65.05



SALE

\$46.95

### JET-KUT® 9 PC File Set - Premium

- Set includes 1 of each:
- 10" Half Round Bastard
  - 10" Mill Bastard
  - 10" Flat Bastard
  - 10" Flat Smooth
  - 10" Round Bastard
  - 8" Half Round Bastard
  - 8" Flat Bastard
  - 8" Mill Bastard
  - 6" Slim Taper

532851 JFS-9V | List \$117.75



SALE

\$84.95



# PROFESSIONAL PRODUCTS - VALUE BY DESIGN

## 40 PC 1/4" Drive SAE / Metric Socket Set



- Chrome Vanadium steel
- 5-1/2" quick release ratchet
- Shallow and Deep: 3/16 – 1/2"
- Shallow and Deep: 4 – 12 mm

020113 ISK-1440SM | List \$85.85

**SALE \$59.95**

## 20 PC 3/8" Drive SAE Socket Set



- 8" Quick release ratchet
- Regular: 3/8 – 3/4"
- Deep: 3/8 – 13/16"

020123 ISK-3820S | List \$99.70

**SALE \$69.95**

## 20 PC 3/8" Drive Metric Socket Set



- 8" quick release ratchet
- Regular: 10 – 22 mm
- Deep: 10 – 19 mm

020124 ISK-3820M | List \$99.70

**SALE \$71.95**

## 49 PC 3/8" Drive SAE / Metric Socket Set



- 8" quick release ratchet
- Regular: 3/8 – 7/8", 6 – 19 mm
- Deep: 3/8 – 7/8", 8 – 19 mm

020125 ISK-3849SM | List \$156.55

**SALE \$112.95**

## 20 PC 1/2" Drive SAE Socket Set



- 10" quick release ratchet
- Regular: 3/8 – 1-1/4"

020133 ISK-1220S | List \$156.55

**SALE \$112.95**

## 200 PC Mechanic's Tool Set



- Torque Drive sockets in 6 point, 12 point, regular and deep
- Includes 3 ratchets: 1/4", 3/8", and 1/2" drive

020304 IMTK-200 | List \$290.95

**SALE \$209.95**

## 21 PC 3/4" Drive SAE Socket Set



- 20" round head ratchet
- Regular 3/4 – 2"
- 12 PT Sockets

020141 ISK-3421 | List \$374.10

**SALE \$269.95**

## 1/2" Drive 13 PC SAE or Metric Impact Socket Sets

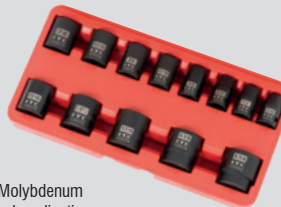

- Heat treated Chrome Molybdenum sockets for professional applications
- Torque-Drive® sockets apply torque to flats of fasteners to prevent corner rounding and increase torque
- Black phosphate finish resists corrosion and will not peel

PROD. NO.	MOD. NO.	Sizes	List	Sale
020723	IPS-1312	7/16 – 1-1/4"	\$78.95	\$56.95
020731	IPS-1312M	10 – 24 mm	\$67.85	\$48.95

## 1/2" Drive 13 PC SAE or Metric Deep Impact Socket Sets



- Heat treated Chrome Molybdenum sockets for professional applications
- Torque-Drive® sockets apply torque to flats of fasteners to prevent corner rounding and increase torque
- Black phosphate finish resists corrosion and will not peel

PROD. NO.	MOD. NO.	Sizes	List	Sale
020728	IPS-1312D	7/16 – 1-1/4"	\$124.65	\$89.95
020736	IPS-1312DM	10 – 24 mm	\$112.20	\$80.95

## 14 PC Polished Combination Wrench Sets



- Drop Forged heat treated Chrome Vanadium steel
- 020210: 3/8 – 1-1/4"
- 020211: 10 – 32 mm

PROD. NO.	MOD. NO.	Measurement Standard	List	Sale
020210	ICW-14PS	SAE	\$62.30	\$44.95
020211	ICW-14PM	Metric	\$62.30	\$44.95

## 10 PC Jumbo Combination Wrench Sets



- Industrial Quality Drop Forged Chrome Vanadium Steel
- 020202: 1-5/16 – 2"
- 020203: 33 – 50 mm

PROD. NO.	MOD. NO.	Measurement Standard	List	Sale
020202	ICWJ-10S	SAE	\$304.80	\$219.95
020203	ICWJ-10M	Metric	\$304.80	\$219.95

## 16 PC Combination Wrench Sets



- Raised panel style
- 020215: 1/4 – 1-1/4"
- 020216: 6 – 32 mm

PROD. NO.	MOD. NO.	Measurement Standard	List	Sale
020215	ICW-16	SAE	\$85.85	\$61.95
020216	ICW-16M	Metric	\$85.85	\$61.95

## 14 PC SAE Angle Wrench Set - 60° & 15°



- Fully polished mirror finish
- 3/8" - 1-1/4"
- 60° & 15°

**020222** IACW-14 | List \$149.60

**SALE \$99.95**

## 14 PC Ergonomic Screwdriver Set



- Chrome Vanadium steel shafts
- Comfortable ABS handles
- 3 x Phillips
- 3 x Square
- 5 x Slot
- 3 x TORX

**020907** IESD-14S | List \$58.15

**SALE \$41.95**

## 7 PC Square Extractor Set



- 1/8 - 9/16"

**024207** ISE-7 | List \$83.10

**SALE \$59.95**

## Steel Pipe Wrenches



- Forged carbon steel hook jaw

PROD. NO.	MOD. NO.	Length	List	Sale
020402	IPW-10	10"	\$16.55	\$11.95
020404	IPW-14	14"	\$22.10	\$15.95
020405	IPW-18	18"	\$34.60	\$24.95
020406	IPW-24	24"	\$48.45	\$34.95
020407	IPW-36	36"	\$84.45	\$60.95

## 5 PC Cushion Grip Pliers Set



- Cushion-grip handles

**020604** IPL-5S | List \$51.20

**SALE \$36.95**

## 13 PC Slide Hammer Puller Set



- Pulls dents, gears and axles

**027405** ISHK-13 | List \$192.55

**SALE \$139.95**

## Adjustable Wrenches



- Heat-treated alloy steel
- Accurate thumb-screw for smooth operation

PROD. NO.	MOD. NO.	Length	List	Sale
020311	IAW-6	6"	\$9.65	\$6.95
020312	IAW-8	8"	\$12.40	\$8.95
020313	IAW-10	10"	\$19.35	\$13.95
020314	IAW-12	12"	\$22.10	\$15.95
020315	IAW-15	15"	\$41.50	\$29.95

## 5 PC Locking Pliers Set



- Tough alloy steel construction
- Comfortable rubber handle grips
- All models complete with wire cutter

**020608** ILPS-5C | List \$65.05

**SALE \$46.95**

## 60 PC SAE / Metric Tap and Die Set



- SAE #4 - 12, 1/4 - 1/2" NC & NF, 1/8" - 27 NPT
- Metric M3-M12

**024312** ITD-60C | List \$181.50

**SALE \$129.95**

## Torque Wrenches



- Click type
- 021801: 120 - 960 in-lb
- 021811: 10 - 150 ft-lb

PROD. NO.	MOD. NO.	Drive	List	Sale
021801	ITW-2060	3/8"	\$84.45	\$60.95
021811	ITW-2063	1/2"	\$102.50	\$73.95

## 10 PC Heat Gun Kit



- 120 volt, 12.5 amps
- Features dual heat settings and fan speeds
- Air Temperature:
  - Low: 375°C (700°F)
  - High: 495°C (925°F)
- Includes many accessories

**011981** SPT270 | List \$56.70

**SALE \$38.95**

## SAE / Metric Tape Measures



- High visibility steel tape

PROD. NO.	MOD. NO.	Size	List	Sale
022010	ITM-316R	3/4" x 16'	\$9.75	\$6.95
022020	ITM-425R	1" x 25'	\$15.45	\$9.95



# PROFESSIONAL PRODUCTS - VALUE BY DESIGN

## 5,500 lb Hydraulic Pallet Truck



- 27" x 48" fork dimensions
- Heavy duty pump for long life

024852 IPT-5500A | List \$710.90

**SALE**

**\$469.95**

## 5" Angle Grinder



- 9 Amp 120V motor
- 10,500 rpm no load speed

011707 IPT-500 | List \$116.40

**SALE**

**\$79.95**

## 3/8" x 50' Retractable Air Hose Reel - Metal



- High grade hardened steel spring
- Max. Pressure: 300 psi

028272 I3850AS | List \$270.20

**SALE**

**\$194.95**

## 3 Ton Hydraulic Service Jack



- Conforms to ANSI standards
- Lifting Range: 5-1/2" – 19-1/2"

024827 ISJ-3A | List \$296.50

**SALE**

**\$209.95**

## 7" Variable Speed Polisher



- 10 Amp 120V motor
- 1,000 – 3,000 rpm no load speed with thumbwheel selector

011713 IPT-700V | List \$203.75

**SALE**

**\$139.95**

## 4 PC Pry Bar Set

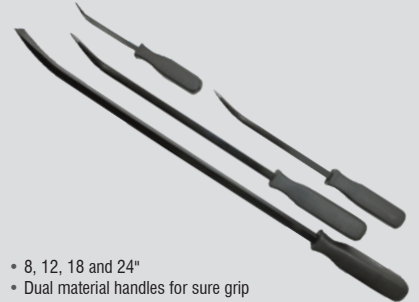

- 8, 12, 18 and 24"
- Dual material handles for sure grip

022925 IMPB-4 | List \$54.00

**SALE**

**\$38.95**

## Bench Grinders



- Heavy duty for professional use
- 1 Standard and 1 Magnifying Eye Shield

PROD. NO.	MOD. NO.	Motor	List	Sale
028016	IBG-6	1/2 HP	\$145.45	\$99.95
028017	IBG-8	3/4 HP	\$199.50	\$139.95

## 1" x 15' 1,500 lb Ratchet Tie Down Set



- Heavy duty weather resistant polyester web
- Rated capacity 1,500 lb

027116 ITD-1154R | List \$48.45

**SALE**

**\$34.95**

## 18 lb x 60" Pinched Point Crow Bar

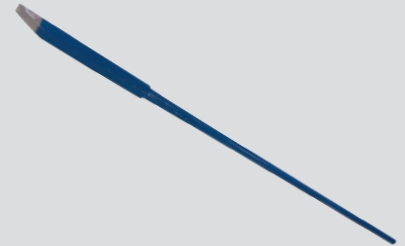

- 18 lb x 60" x 1-3/8" shank

022937 IPB-6018 | List \$83.10

**SALE**

**\$59.95**

## Non-Contact Infrared Thermometer



- Allows accurate measurement of temperature without contact
- Measuring range: -20°C to 520°C / -4°F to 968°F

027591 IRT-520 | List \$146.85

**SALE**

**\$99.95**

## 12 PC Jumbo Punch and Chisel Set

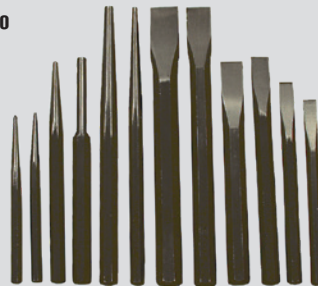

- Jumbo style for big jobs
- Vinyl pouch

023505 IPC-12 | List \$81.70

**SALE**

**\$59.95**

## 16 PC Punch and Chisel Set



- Dual heat-treated Chrome Vanadium steel

023508 IPC-16 | List \$66.45

**SALE**

**\$47.95**



### SMD/COB Headlamps

849822



849823

- Combination SMD and COB technology for long distance or wide angle lighting
- Cree XPG SMD provides the ultimate in long distance lighting
- Both light sources feature Low, High, Strobe, and Variable functions
- 849823: USB Rechargeable

PROD. NO.	MOD. NO.	Run Time @ Low Power	Lumens @ High Power	List	Sale
849822	JLHL-250	10 hrs	250	\$36.15	\$27.95
849823	JUHL-250	10 hrs	250	\$51.65	\$39.95

### LED Headlamp



- SMD Technology
- Up to 100,000 hours lifetime
- Tilts 9 positions

849821 JLHL-220 | List \$50.10

**SALE \$39.95**

### COB Pivot Light



- Combination COB and SMD technology for use as a work light or flashlight
- Lithium-Ion battery is USB chargeable using any compatible charging block
- Pivot base with integrated magnet allows light to stand on any surface or be mounted to any metal surface
- Combination suspension hook and belt hook for mounting light or conveniently attaching to your belt

849854 JUPL-240 | List \$64.60

**SALE \$49.95**

### COB Work Light with UV Detection



- Combination COB and UV technology for use as a work light or leak detection light
- Lithium-Ion battery is USB chargeable using any compatible charging block
- Ultra-thin wand gets light into the tightest spaces
- Wand rotates 180° and locks in 8 positions to put the light where you need it

849855 JUFL-230UV | List \$77.55

**SALE \$59.95**

### LED Penlight - 100 Lumens



- SMD Technology
- Up to 100,000 hours lifetime

849802 JLPL-100 | List \$52.95

**SALE \$39.95**

### Folding COB Work Light



- Combination COB and SMD technology for use as a work light or flashlight
- Lithium-Ion battery is USB chargeable using any compatible charging block
- Ultra-thin wand gets light into the tightest spaces
- Wand moves 180° and rotates 270° to put the light where you need it

849856 JUFL-500 | List \$116.35

**SALE \$89.95**

### LED Flashlight - 600 Lumens - with USB charger



- SMD Technology
- Up to 100,000 hours lifetime

849819 JLFL-600U | List \$84.00

**SALE \$64.95**

### Aluminum Pivot Base Work Light

**SUPER SPECIAL**



- Super bright COB element with aluminum reflector provides up to 400 lumens of shadow-free light
- Robust all aluminum body stands up to the toughest environments
- Rechargeable Lithium-Ion battery works when on the charger for longer working time
- Pivot base with integrated magnet and suspension hook provides hands-free options

849241 JAPL-400SHD | List \$64.60

**SALE \$39.95**

### Contractor Grade Extension Cords - Tri Tap



- SJTOW cord rated to -50°C
- Light indicates live power

PROD. NO.	MOD. NO.	Gauge	Length	List	Sale
849881	JLEC-1425	14 SJTOW	25'	\$34.35	\$24.95
849882	JLEC-1450	14 SJTOW	50'	\$57.70	\$43.95
849884	JLEC-14100	14 SJTOW	100'	\$108.05	\$79.95
849886	JLEC-1225	12 SJTOW	25'	\$45.40	\$34.95
849887	JLEC-1250	12 SJTOW	50'	\$84.75	\$64.95
849889	JLEC-12100	12 SJTOW	100'	\$162.10	\$119.95

### Contractor Grade Extension Cords - Single Tap



- SJTOW cord rated to -50°C
- Light indicates live power

PROD. NO.	MOD. NO.	Gauge	Length	List	Sale
849861	JLEC-1425S	14 SJTOW	25'	\$29.45	\$22.95
849862	JLEC-1450S	14 SJTOW	50'	\$50.30	\$39.95
849864	JLEC-14100S	14 SJTOW	100'	\$94.55	\$72.95
849866	JLEC-1225S	12 SJTOW	25'	\$41.70	\$32.95
849867	JLEC-1250S	12 SJTOW	50'	\$82.25	\$59.95
849869	JLEC-12100S	12 SJTOW	100'	\$151.10	\$119.95