

▼ Shown from left to right: ZU4304MB, ZU4420SBH



ZU Series

Reservoir Capacity:

1.2 - 10.3 gallon

Flow at Rated Pressure:

60 in³/min.

Motor Size:

1.7 hp

Maximum Operating Pressure:

10,000 psi

- Features **Z-Class** high-efficiency two-stage pump design; higher oil flow and bypass pressure, cooler running and requires 18% less current draw than comparable pumps
- Powerful 1.7 hp universal electric motor provides high power-to-weight ratio and excellent low-voltage operating characteristics
- High-strength, molded composite shroud protects motor and electronics, while providing an ergonomic, non-conductive handle for easy transport
- Low-voltage pendant provides additional safety for the operator (remote control units)

Pro-Series pumps only

- LCD readout provides pressure and a number of diagnostic and readout capabilities on a portable electric pump
 - pump usage information, hour and cycle counts
 - self-test, diagnostic and read-out capabilities
 - pressure readout and auto-mode pressure settings



Assisted Return Pumps with Venturi Valve Technology

To improve productivity and plunger retraction, Enerpac offers valve configurations

designed to accelerate your cylinder retraction speeds, ZU4-Series pumps feature Venturi Valve Technology to facilitate the faster return of single-acting gravity return cylinders.

See details in the "Directional Control Valve" section.

Page: 141



Speed Chart

To determine how a "Z" pump will operate your cylinder, see the Pump/Cylinder Speed Chart in the "Yellow Pages".

Page: 409



◀ *Designed to be tough, the ZU4-Series with steel reservoirs will take the abuse of today's construction sites.*

ZU-Series Specifications and Dimensions

ZU4 Performance							
Motor Size (hp)	Output Flow Rate (in ³ /min)				Motor Electrical Specification (volts-ph-Hz)	Sound Level (dBA)	Relief Valve Adjustment Range (psi)
	100 psi	700 psi	5000 psi	10,000 psi			
1.7	700	535	76	60	115-1-50/60 230-1-50/60	85-90	2,000-10,000

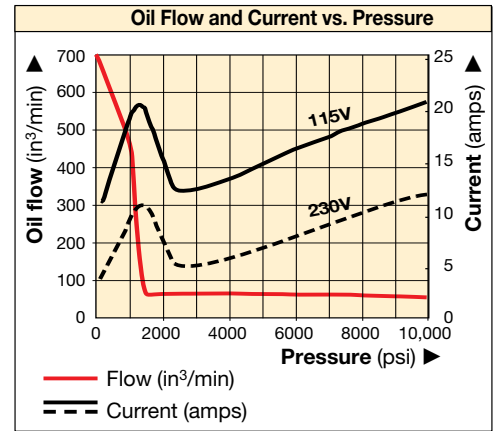

ZU4 Series with 1.2 and 1.8 gallon reservoirs

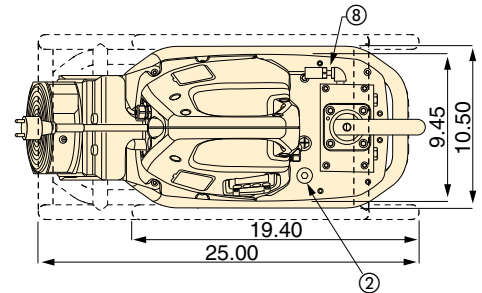
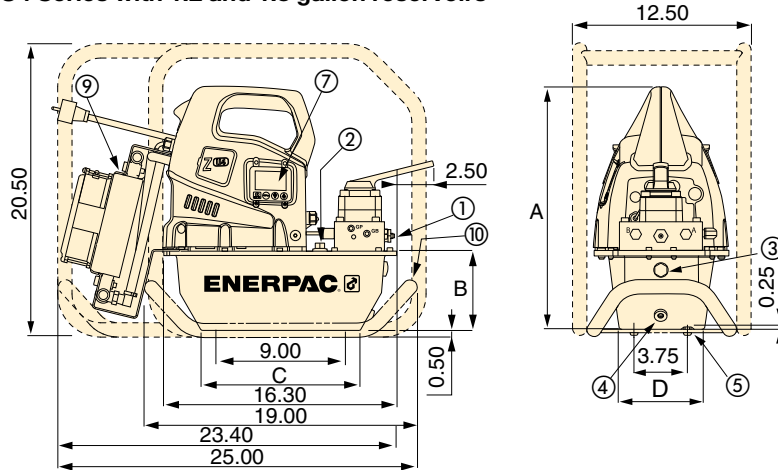

ZU-4 Series with 5.2 and 10.3 gallon reservoirs (Left view shown without side handle)

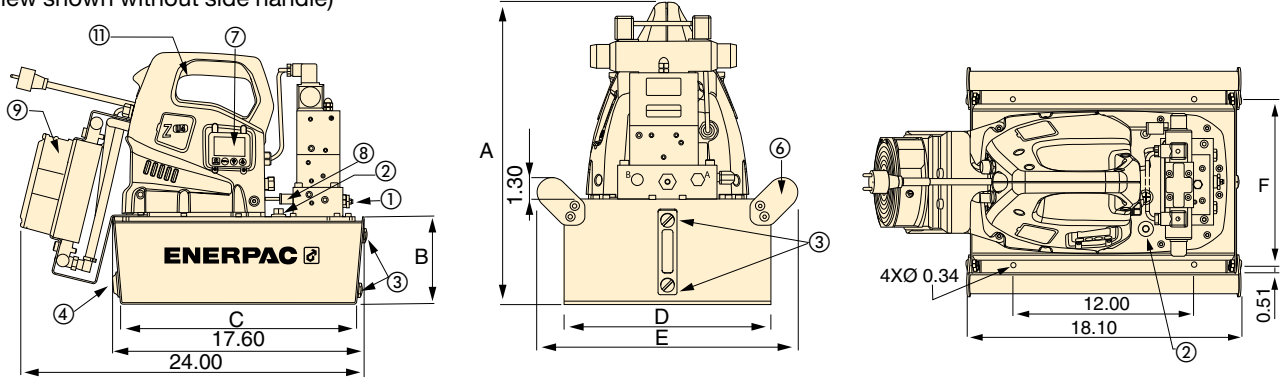

- ① User adjustable relief valve
- ② Oil fill port, SAE#10
- ③ Oil level sight gauge
- ④ Oil Drain, 1/2" NPTF
- ⑤ M8 x 1.25
- ⑥ Handles on all 5.2 and 10.3 gallon reservoirs
- ⑦ Back-lit LCD Electric
- ⑧ Pressure transducer
- ⑨ Heat exchanger
- ⑩ Skid bar
- ⑪ Handle guard installed on all 5.2 and 10.3 gallon reservoirs
- ⑫ Reservoir handles (not shown) included on all 5.2 and 10.3 gallon pumps



◀ Increased output flow and extended brush life increase productivity for post-tensioning applications.

Reservoir Capacity (gal)	Pump Dimensions (in)					
	A	B	C	D	E	F
1.2	16.7	5.6	11.0	6.0	-	-
1.8	16.7	5.6	11.0	8.1	-	-
5.2	18.3	7.1	16.5	16.6	19.7	15.6
10.3	21.7	10.6	15.7	19.9	22.7	18.9

▼ STEP 1: Select a pump from the Pump Ordering Matrix.

The functionality of the pump can be determined by the model number. Utilize the guide below to select the best pump for the application from the pump matrix.

Z	U	4	4	08	J	B	-	H	R
1	2	3	4	5	6	7		8	
Product Type	Motor Type	Flow Group	Valve Type	Reservoir Size	Valve Operation	Voltage		Factory Installed Accessories	

1 Product Type

Z = Pump Series

2 Motor Type

U = Universal electric motor

3 Flow Group

4 = 60 in³/min @ 10,000 psi

4 Valve Type

- 1** = Dump (VE32D)
- 2** = 3 way/2 position manual or electric (VM32 or VE32)
- 3** = 3 way/3 position manual or electric (VM33 or VE33)
- 4** = 4 way/3 position manual or electric (VM43 or VE43)
- 6** = 3 way/3 position locking manual w/po check (VM33L)
- 7** = 3 way/2 position manual (VM22)
- 8** = 4 way/3 position locking manual w/po check (VM43L)
- 9** = 4 way/3 position manual w/power seating (VM43LPS)
- 10** = 3 way/3 position manual, Venturi-Valve (VM33VAC)
- 11** = 3 way/3 position electric, Venturi-Valve (VE33VAC)

5 Reservoir Capacity

- 04** = 1.2 gallon
- 08** = 1.8 gallon
- 20** = 5.2 gallon (includes side handles)
- 40** = 10.3 gallon (includes side handles)

6 Valve Operation

- D** = Dump solenoid valve with pendant and LCD Electric
- J** = Jog manual valve with pendant (w/o LCD)
- L** = Manual valve w/LCD Electric (w/o pendant)
- M** = Manual valve (without pendant and LCD)
- P** = Manual valve with pendant (w/o LCD)
- S** = Solenoid valve with pendant and LCD Electric

7 Voltage

- B** = 115V, 1 ph, 50/60Hz
- E** = 208-240V, 1 ph, 50/60 Hz (w/European plug and CE EMC compliant)
- I** = 208-240V, 1 ph, 50/60 Hz (w/NEMA 6-15 plug)

▼ STEP 2 Factory Installed Accessories

Select factory installed accessories and add to the pump model number after the hyphen. The example above shows that a **Roll Cage (R)** and **Heat Exchanger (H)** have been added to the pump.

8 Factory installed accessories include the following:

- | | |
|---|--------------------------------|
| F = Return Line Filter | R = Roll cage |
| G = Pressure Gauge ¹⁾ | K = Skid Bar |
| H = Heat Exchanger | T = Pressure Transducer |
| L = Level/Temperature Switch ²⁾ | U = Foot Switch |
| N = Lifting Eyes (no reservoir handles) | |

^{1)+2):} See the notes about Pressure Gauge and Level/Temperature Switch in right column.

ZU Series



Reservoir Capacity:

1.2 - 10.3 gallon

Flow at Rated Pressure:

60 in³/min.

Motor Size:

1.7 hp

Maximum Operating Pressure:

10,000 psi



Z-Class – A Pump For Every Application

Patented Z-Class pump technology provides high

by-pass pressures for increased productivity—important in applications using long hose runs and high pressure-drop circuits, like heavy lifting or certain double-acting tools.

Enerpac ZU4 Hydraulic Pumps are built to power small to large-sized cylinders or hydraulic tools, or wherever high-speed, intermittent duty, remote hydraulic power is needed.

Pro Electric Pump

Digital (LCD) display features a built-in hour meter and shows self-diagnostic, cycle-count and low voltage warning information.

Pressure can also be displayed when the pump is equipped with a pressure transducer.





















Pressure Gauge, Level/Temperature Switch

¹⁾ Pressure Gauge (**G**) not available on pump models with pressure transducer (**T**). The pressure transducer provides digital pressure read-out on LCD-display.









²⁾ Level/Temperature Switch (**L**) requires electric package. Not available on reservoirs 04 and 08.

ZU-Series Pump Ordering Matrix

▼ ZU-SERIES MANUAL PUMP MODELS

	S/A or D/A ¹⁾	Hold 	Valve Type ²⁾	Reservoir Capacity (gal)	Unit Weight w/ oil ⁵⁾ (lbs)	Model Number 115 VAC, 1 Phase ³⁾		
						Manual Only	Standard Electric w/ Pendant	Classic Electric w/ Pendant ⁴⁾
<ul style="list-style-type: none"> • Ideal choice for most applications • Manual valve control, for single-acting or double-acting applications • Motor control on shroud • Venturi Valve technology (VM33VAC) for faster retract of single acting cylinders • Pendant models ideal for light production and lifting applications • Locking valves provide hydraulic locking of cylinder until valve is shifted into retract position 	S/A		VM22	1.2	59	ZU4704MB (I, E)		ZU4704PB (I, E)
	S/A		VM22	1.8	65	ZU4708MB (I, E)		ZU4708PB (I, E)
	S/A		VM22	5.2	108	ZU4720MB (I, E)		ZU4720PB (I, E)
	S/A		VM32	1.2	55	ZU4204MB (I, E)	ZU4204JB (I, E)	
	S/A		VM32	1.8	61	ZU4208MB (I, E)	ZU4208JB (I, E)	
	S/A		VM32	5.2	104	ZU4220MB (I, E)	ZU4220JB (I, E)	
	S/A		VM32	10.3	155	ZU4240MB (I, E)	ZU4240JB (I, E)	
	S/A		VM33	1.2	56	ZU4304MB (I, E)		
	S/A		VM33	1.8	62	ZU4308MB (I, E)	ZU4308JB (I, E)	ZU4308PB (E)
	S/A		VM33	5.2	106	ZU4320MB (I, E)	ZU4320JB (I, E)	ZU4320PB (E)
	S/A		VM33	10.3	156	ZU4340MB (I, E)	ZU4340JB (I, E)	ZU4340PB (E)
	S/A		VM33VAC	1.8	63	ZU41008MB (E)	ZU41008JB (E)	
	S/A		VM33VAC	5.2	106	ZU41020MB (E)	ZU41020JB (E)	
	S/A		VM33L	1.8	66	ZU4608MB (E)	ZU4608JB, (E)	
	S/A		VM33L	5.2	109	ZU4620MB (E)	ZU4620JB, (E)	
	D/A		VM43	1.8	63	ZU4408MB (I, E)	ZU4408JB (I, E)	ZU4408PB (E)
	D/A		VM43	5.2	106	ZU4420MB (I, E)	ZU4420JB (I, E)	ZU4420PB (E)
	D/A		VM43	10.3	156	ZU4440MB (I, E)	ZU4440JB (I, E)	ZU4440PB (E)
	D/A		VM43L	1.8	67	ZU4808MB (E)	ZU4808JB (E)	
D/A		VM43L	5.2	110	ZU4820MB (E)	ZU4820JB (E)		

▼ ZU-SERIES PRO SOLENOID VALVE MODELS WITH PENDANT AND LCD ELECTRIC

	S/A or D/A ¹⁾	Neutral 	Valve Type ²⁾	Reservoir Capacity (gal)	Unit Weight w/ oil (lbs)	Model Number 115 VAC, 1 Phase ³⁾
<ul style="list-style-type: none"> • Ideal for punching, crimping and cutting • For use when load-holding is not required 	S/A		VE32D	1.8	69	ZU4108DB (I, E)
	S/A		VE32D	5.2	112	ZU4120DB (I, E)
SINGLE AND DOUBLE ACTING MODELS	S/A		VE32	1.2	63	ZU4204SB (I, E)
<ul style="list-style-type: none"> • Ideal for lifting applications and where remote control is required • Motor runs continuously on pumps with VE33 and VE43 valves. • With VE32 valve, motor only runs during the advance function, while holding and retracting, the motor is off • Venturi Valve technology (VE33VAC) for faster retract of single-acting cylinders 	S/A		VE32	1.8	69	ZU4208SB (I, E)
	S/A		VE32	5.2	112	ZU4220SB (I, E)
	S/A		VE33	1.8	81	ZU4308SB (I, E)
	S/A		VE33	5.2	124	ZU4320SB (I, E)
	S/A		VE33	10.3	174	ZU4340SB (I, E)
	S/A		VE33VAC	1.8	74	ZU41108SB (E)
	S/A		VE33VAC	5.2	117	ZU41120SB (E)
	S/A		VE33VAC	10.3	168	ZU41140SB (E)
	D/A		VE43	1.8	81	ZU4408SB (I, E)
	D/A		VE43	5.2	124	ZU4420SB (I, E)
	D/A		VE43	10.3	174	ZU4440SB (I, E)

¹⁾ S/A or D/A = Single acting or double-acting pumps

²⁾ Additional details can be found in the Directional Control Valve section

³⁾ "I" indicates pump is available in 208-240V, 1-phase, 50/60 Hz with NEMA 6-15 plug. Model number order example: ZU4208MI.

"E" indicates pump is available in 208-240V, 1-phase, 50/60 Hz with European plug and CE CMC compliant. Model number order example: ZU4208ME.

⁴⁾ Classic Electric Pump has traditional electro-mechanical components (transformers, relays, switches) in place of solid-state electronics.

⁵⁾ Manual weights given, Standard Electric w/pendant add 1lb and Classic Electric w/pendant add 3 lbs.

Note: Valve Operation L available on Manual Pumps. Substitute "L" for "M" Valve Operation



Roll Cage (R)

- Protects and stabilizes the pump

Popular Pump Models with Factory Installed Roll Cages	
ZU4108DBR (I, E)	ZU4308MBR (I, E)
ZU4208JBR (I, E)	ZU4320MBR (I, E)
ZU4220JBR (I, E)	ZU4408MBR (I, E)
ZU4208SBR (I, E)	ZU4420MBR (I, E)
ZU4308JBR (I, E)	ZU4408JBR (I, E)
ZU4320JBR (I, E)	ZU4420JBR (I, E)
ZU4308SBR (I, E)	ZU4408SBR (I, E)
ZU4320SBR (I, E)	ZU4420SBR (I, E)

Accessory Kit No.	Fits on Reservoir
ZRC-04	1.2 and 1.8 gallon ¹⁾
ZRC-04H	1.2 and 1.8 gallon ²⁾
ZRB-20	5.2 gallon
ZRB-40	10.3 gallon

¹⁾ Without heat exchanger ²⁾ With heat exchanger



Foot Switch (U)

- 10 ft. cord, hands-free control

Popular Pump Models with Factory Installed Foot Switch
ZU4108DBU (I, E)
ZU4208SBU (I, E)
ZU4220SBU (I, E)
ZU4320SBU (I, E)
ZU4408SBU (I, E)
ZU4420SBU (I, E)

Accessory Kit No.	Can be used on ZU4 Pumps with solenoid dump and 3-position valves, LCD electric
ZCF-2	Solenoid VE-Series valves



Heat Exchanger (H)

- Removes heat from bypass oil
- Increases oil life, reduces wear on hydraulic components

Popular Pump Models with Factory Installed Heat Exchanger
ZU4108DBH (I, E)
ZU4208SBH (I, E)
ZU4308SBH (I, E)
ZU4408SBH (I, E)
ZU4420SBH (I, E)

Accessory Kit No.	Can be used on
ZHE-U115	115V pumps
ZHE-U230	230V pumps



Pressure Transducer (T)

- More durable than analog gauges
- Displays psi, bar or Mpa
- Motor shutoff or shift to neutral at set pressure

Popular Pump Models with Factory Installed Pressure Transducer, Requires LCD Electric Pump
ZU4108DBT (I, E)
ZU4208SBT (I, E)
ZU4308SBT (I, E)
ZU4408SBT (I, E)
ZU4420SBT (I, E)

Accessory Kit No.	Adjustable Pressure Range (psi)	Switch-Point Repeatability	Dead-band (psi)
ZPT-U4	50-10,000	± 0.5%	50

Note: The pressure transducer provides digital pressure read-out on LCD-display.

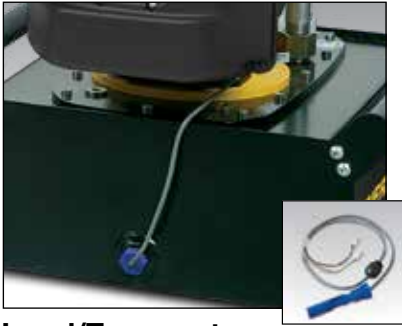

Level/Temperature Switch (L)

- Shuts off pump when high operating temperature or low oil is reached
- Plugs directly into pump electrical enclosure
- Easy installation to pump reservoir
- Requires LCD electric

Model Number	Operating Temperature (° F)	Maximum Pressure (psi)	Wt. (lbs)
ZLS-U4	40-230	150	0.11



Return Line Filter (F)

- 25 micron filter removes contaminants from return oil flow
- Internal by-pass valve prevents damage if filter is dirty
- Features maintenance indicator

Accessory Kit Model Number	Maximum Pressure (psi)	Maximum Oil Flow (GPM)	By-pass Setting (psi)
ZPF	200	12.0	25

ZU Series



Reservoir Capacity:

1.2 - 10.3 gallon

Flow at Rated Pressure:

60 in³/min.

Motor Size:

1.7 hp

Maximum Operating Pressure:

10,000 psi



Heat Exchanger

- Stabilizes oil temperature at a maximum of 130° F at 70° F ambient temperature.

Not suitable for water-glycol or water based fluid.

Thermal Transfer *	Maximum pressure (psi)	Maximum oil flow (GPM)	Voltage (VDC)
Btu/h			
900	300	7.0	12

* At GPM at 70 °F ambient temperature.



Skidbar (K)

- Provides easy two-hand lift
- Provides greater pump stability on soft or uneven surfaces
- Cannot be used in combination with roll cage

Accessory Kit No.	For ZU-Series Pumps with 1.2 and 1.8 Gallon Reservoir	Wt. (lbs)
SBZ-4	1.2-1.8 gal. w/o heat exchanger	4.9
SBZ-4L	1.2-1.8 gal. with heat exchanger	5.5



Pressure Gauge (G)

- Minimize risk of overloading to ensure long life of equipment
- 2.5" face diameter, glycerin filled
- Dual Scale, PSI and Bar

Model No.	Description
G2536L	15,000 psi, Ø 2.5 inches

Note: Pressure Gauge not available on pump models with pressure transducer. The pressure transducer provides digital pressure read-out on LCD-display.